

HOUSE OF FORGINGS

STAIR & RAILING PRODUCTS



Edition 001-B

STAIR & RAILING PRODUCTS BY

 **HOUSE OF FORGINGS**





353 Greens Landing Dr.  
Houston, Texas 77038  
Toll Free 866.443.4848 Fax 281.443.1133  
[www.houseofforgings.net](http://www.houseofforgings.net)

Front cover photo courtesy of  
Homes by Sal Cohen - Bellevue, WA

Please contact us for more detailed information  
or for a listing of suppliers near you.

Edition 001-8

*Whether your customer is a homeowner, retailer, or homebuilder, the timeless design and quality craftsmanship of House of Forgings' stair and railing products will attract the attention of the most discerning eye.*

*Our impeccably crafted styles are originally designed in partnership with our Italian studio and created with the sense of pride in workmanship that can only be found in an employee owned company. We fashion stairs and railings from the finest materials available so that what you provide to your clients is unsurpassed in style, uncompromising in quality, and unmatched in elegance.*

*We manufacture over 2,000 active SKUs in over 200,000 square feet of warehouse space with a national distribution network that ships to you in under 24 hours. No one else comes close to the brilliantly executed design, construction, and service you'll experience only at House of Forgings.*



# Table of Contents

POWDER COATED & STAINLESS STEEL	3-63
Finishes & Patinas	4-5
Stainless Steel Cable Railing	6-9
Horizontal Bar Railing	10-15
Harmony	16-17
Soho	18-19
Foundation	20-21
Mega	22-23
Wentworth	24-27
Aalto	28-31
Tuscan	32-37
Designer	38-39
Monte Carlo	40-41
Stainless	42-43
Gothic	44-45
Round	46-49
Versatile	50-53
Ribbon	54-57
Twist	58-61
Accessories	62-63
FORGED PANELS	64-85
Rebecca	65-67
Tuscany	68-71
Seville	72-73
Milano	74-76
Bordeaux	78-81
Regency	82-85
WOOD	86-100
Newels & Balusters	88-93
Handrail & Fittings	94-95
Treads	96-97
Starter Steps	98
Lumber & Plywood	98
Moulding	99
Accessories	100
AXIA STAIR & RAILING SYSTEMS	101
SALES & MARKETING SUPPORT	102-103
CUSTOM IRON FABRICATION & FINISHING	104

## Powder Coated & Stainless Steel

**House of Forgings**  
is the benchmark in  
the stair and railing  
industry, offering an  
unsurpassed  
selection of quality  
products and  
expert service.

Our vast selection of products will meet the needs of even the most discerning customers. Whether selecting a powder coated finish or stainless steel, our newels, balusters and accessories will compliment a broad range of architectural styles.

STAIR & RAILING PRODUCTS BY



# Finishes & Patinas



SATIN BLACK (STB)



ASH GREY (AG)



COPPER VEIN (CV)



OIL RUBBED COPPER (ORC)



OIL RUBBED BRONZE (ORB)

House of Forgings provides an unsurpassed selection of designs in the highest quality powder coated finishes available. Our hand applied patinas enhance the lines and hammered detail of each unique piece. As interior design trends move forward, count on us to carry the latest styles & finishes.



**SATIN CLEAR (SC)**

*This is a clear finish over RAW/unfinished iron, variations in surface color may occur.*



**DORADO GOLD (GD)**



**STAINLESS STEEL (Satin Polish)**



**BRASS (Satin Polish)**

*Passivated to minimize tarnishing, use gloves when handling.*



**BRUSHED CHROME (BC)**



**NICKEL (NL)**



**POLISHED BRASS (PB)**

THESE FINISHES HAVE BEEN PROFESSIONALLY PHOTOGRAPHED WITH THE HIGHEST INTEGRITY. OUR GOAL IS TO PRODUCE THE MOST REALISTIC MATCH TO THE ACTUAL FINISHES, HOWEVER SOME SLIGHT VARIANCES MAY OCCUR. All images are the sole property of House of Forgings, LLC, and cannot be copied or reproduced without written permission.

— Stainless Steel —  
Cable Railing



Red Oak 4000 Newels, 6084 Handrail with stainless round bar bracket (shown)

Create the ideal modern aesthetic by combining stainless steel cable and rich oak. The expansive views allowed for by cable make it ideal for balconies as well as staircases.





# SWAGED CABLE INFILL KITS FOR WOOD OR METAL POSTS

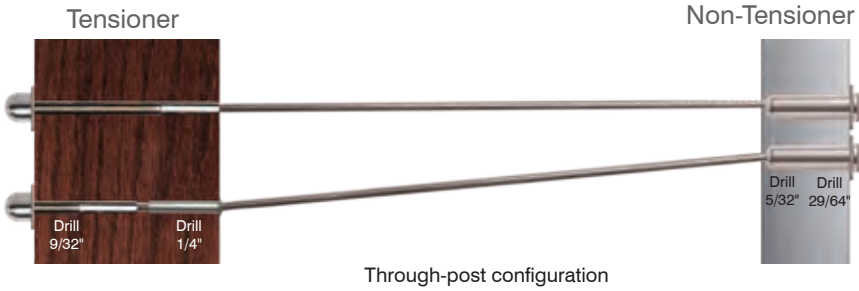

Through-post configuration

Outside to outside  
Level/balcony or angle/stair  
Steel or wood posts

<b>HFC18.102-5</b>	5'	.15 kgs (.331 lbs)
<b>HFC18.102-10</b>	10'	.227 kgs (.5 lbs)
<b>HFC18.102-15</b>	15'	.303 kgs (.669 lbs)
<b>HFC18.102-20</b>	20'	.383 kgs (.844 lbs)

Pre-assembled kit includes fittings and factory swaged cable in lengths 5'-20'



Included in kit



**MINIMUM BREAKING STRENGTH - Cable Diameter 1/8" = 1,780 lbs.**  
**1X19 STRAND TYPE 316 STAINLESS STEEL CABLE**

1 x 19 Cable - 1/8" Diameter



AISI 316

Cable Cutter



**HFC18.CUTTER**

Cable cut-off wheel



**HFC18.WHEEL**

Drill Kit  
Metal Post



**AX00.070.635**

Drill Kit  
Wood Post



**AX00.070.630**

## EASY AS 1-2-3

- 1. What posts are you using? Wood or metal?**
- 2. Measure your level and stair runs, calculate number of level and stair fittings.**
- 3. Add up tensioners and non-tensioners, then calculate total cable footage (plus 5%).**

### Push-Lock® Fittings

Push-Lock fittings do not require any special tools for installation. Simply push the cable into the fitting and it locks.



Tension each row of cable equally to 225 lbs making sure not to over tighten. Use tension gauge to accurately measure tension.

**HFC18.TENSION.GAUGE**

**Recommended Tensioning Sequence**

# SWAGELESS CABLE INFILL FOR WOOD OR METAL POSTS

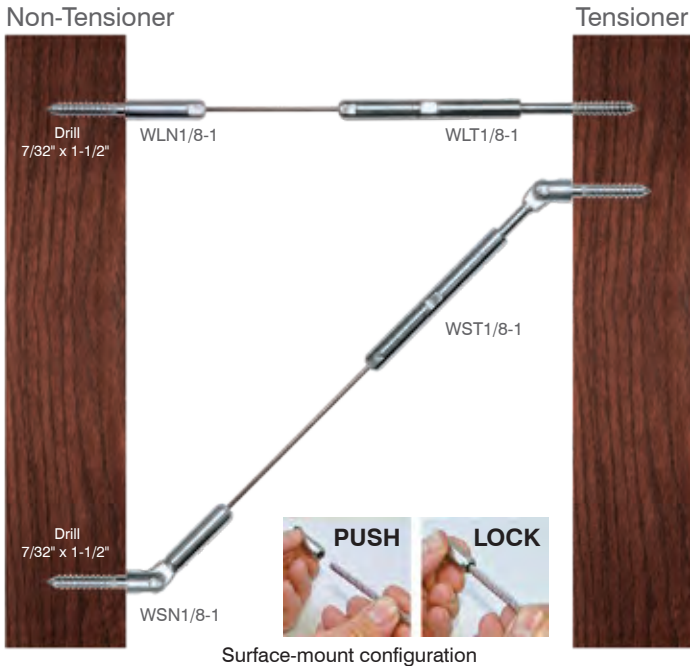

Surface-mount configuration



Inside to inside  
Level/balcony or angle/stair  
Wood posts

For use with 1/8" cable

<b>WLN1/8-1</b>	Wood Level Non Tensioner	.04 kgs (.092 lbs)
<b>WLN1/8-10</b>	Wood Level Non Tensioner(10 pack)	.31 kgs (.693 lbs)
<b>WLT1/8-1</b>	Wood Level Tensioner	.07 kgs (.173 lbs)
<b>WLT1/8-10</b>	Wood Level Tensioner(10 pack)	.68 kgs (1.5lbs)
<b>WSN1/8-1</b>	Wood Stair Non Tensioner	.06 kgs (.135 lbs)
<b>WSN1/8-10</b>	Wood Stair Non Tensioner(10 pack)	.5 kgs (1.12 lbs)
<b>WST1/8-1</b>	Wood Stair Tensioner	.09 kgs (.217 lbs)
<b>WST1/8-10</b>	Wood Stair Tensioner(10 pack)	.88 kgs (1.94 lbs)

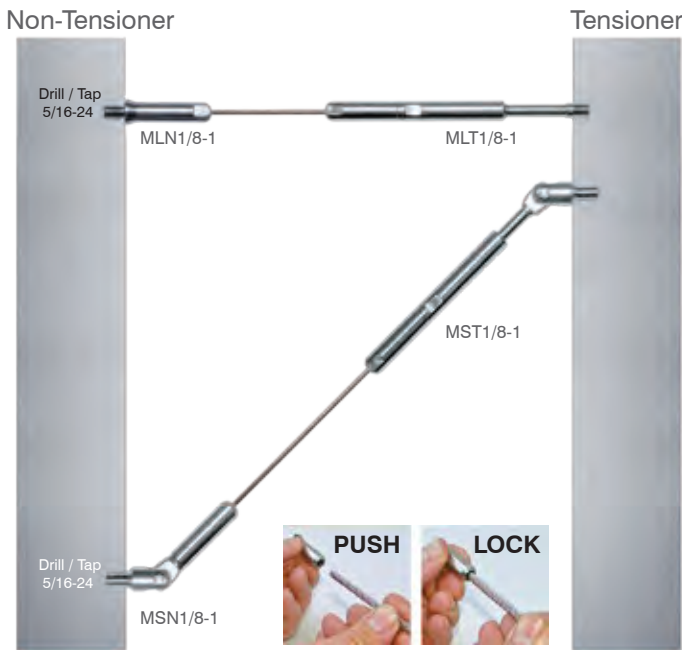
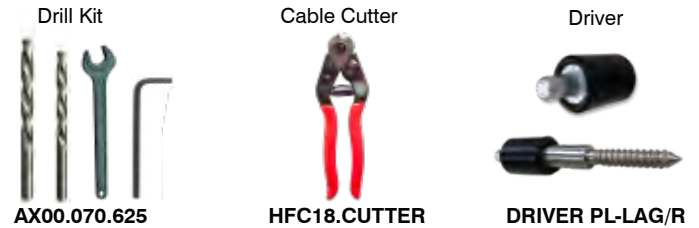

Surface-mount configuration



Inside to inside  
Level/balcony or angle/stair  
Metal posts

For use with 1/8" cable

<b>MLN1/8-1</b>	Metal Level Non Tensioner	.04 kgs (.087 lbs)
<b>MLN1/8-10</b>	Metal Level Non Tensioner(10 pack)	.29 kgs (.638lbs)
<b>MLT1/8-1</b>	Metal Level Tensioner	.07 kgs (.158 lbs)
<b>MLT1/8-10</b>	Metal Level Tensioner(10 pack)	.61 kgs (1.349 lbs)
<b>MSN1/8-1</b>	Metal Stair Non Tensioner	.05 kgs (.118 lbs)
<b>MSN1/8-10</b>	Metal Stair Non Tensioner(10 pack)	.6 kgs (1.349 lbs)
<b>MST1/8-1</b>	Metal Stair Tensioner	.09 kgs (.202 lbs)
<b>MST1/8-10</b>	Metal Stair Tensioner(10 pack)	.81 kgs (1.793 lbs)

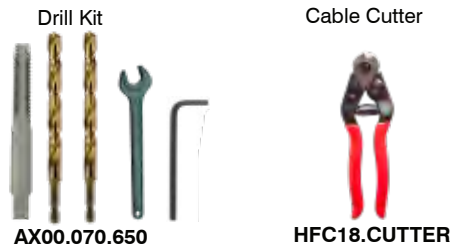

AISI 316

<b>UTCABLE100-4</b>	100' coil - 1/8" 1X19 type 316 S/S cable	2.07 kgs (4.56 lbs)
<b>UTCABLE500-4</b>	500' spool - 1/8" 1X19 type 316 S/S cable	10.02 kgs (22.1 lbs)

1x19 Cable(1/8" 316)

**MINIMUM BREAKING STRENGTH - Cable Diameter 1/8" = 1,780 lbs.  
1X19 STRAND TYPE 316 STAINLESS STEEL CABLE**



Ash Grey (shown)

SATIN BLACK  
SATIN BLACK

**HFSTB5.1.1** (.078" - 2mm)  
**HFSTB7.1.1** (.039" - 1mm)

Powder Coated Tubular Round Bar 5/8" Dia. x 8'  
Powder Coated Tubular Round Bar 5/8" Dia. x 8'

OIL RUBBED BRONZE **HFORB5.1.1**

Powder Coated Tubular Round Bar 5/8" Dia. x 8'

ASH GREY

**HFAG5.1.1**

Powder Coated Tubular Round Bar 5/8" Dia. x 8'

STAINLESS STEEL

**HFSS5.1.1**

304 Grade Stainless Steel Round Bar 5/8" Dia. x 8'  
Satin Polish Finish

Our tubular bar is made with superior 12 gauge(2 mm / 5/56") stock for minimal deflection

# HORIZONTAL RAILING

Now available exclusively from House of Forgings, powder coated and stainless steel tubular round bars. These sleek 5/8" bars are available in a convenient 8' length, ideal for installation and affordable shipping. Mix and match them with our exclusive components for a look that is completely custom and uniquely you.



Satin Black (shown)

Photo courtesy of Mark Anderson Construction - Kennewick, WA



Stainless Steel (shown)

Photo courtesy of MJB Stairs - Shelby Township, MI



Stainless Steel (shown)



Ash Grey (shown)



Satin Black (shown)

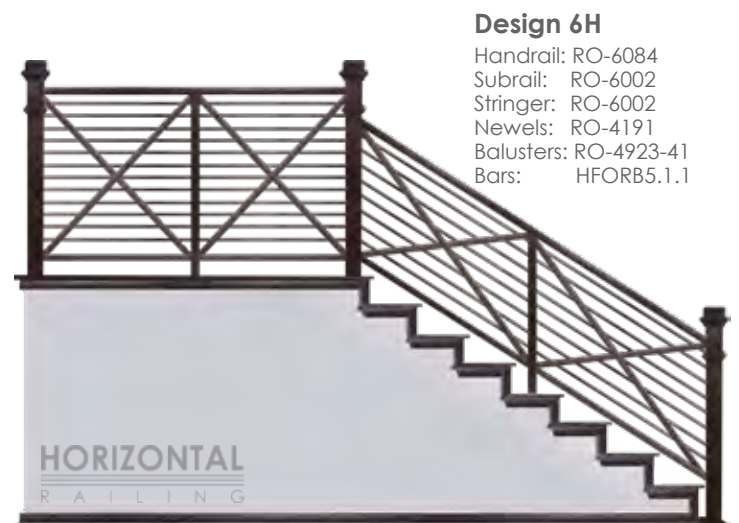
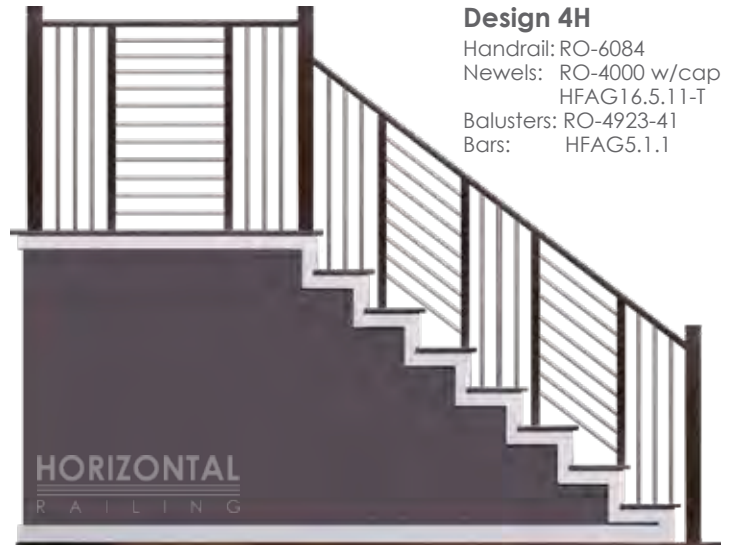
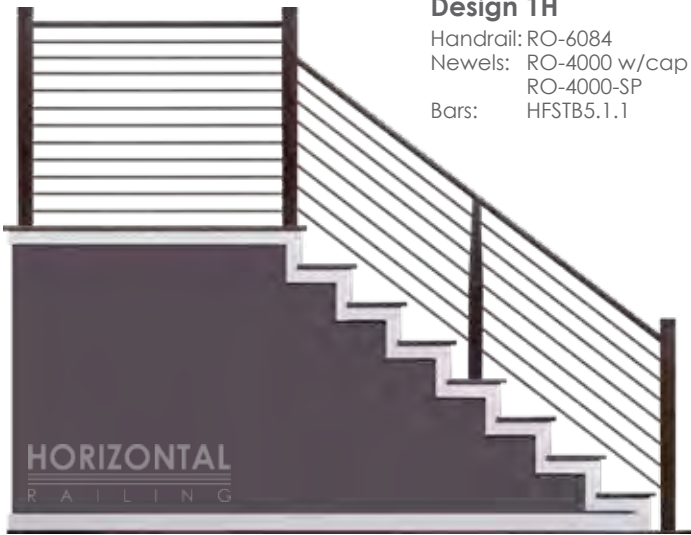



**Design 1FK**

Handrail: RO-6084

Newels:

Starting: RO-5400

Intermediate: RO-4400

Bars: HFSTB5.1.1

**Design 2FK**

Handrail: RO-6084

Newels:

Starting: RO-5900

Intermediate: RO-4900

Bars: HFSTB5.1.1



**Design 3FK**

Handrail: RO-6084

Newels:

Starting: RO-5000

Shown w/ optional COVE CAP-5000

Intermediate: RO-4000

Shown w/ optional COVE CAP-4000

Bars: HFSTB5.1.1



— Stainless Steel —  
**Cable Railing**

**HORIZONTAL**  
**R A I L I N G**

**ACCESSORIES**



**Box Newels**

Non removable caps  
 Stocked in Red Oak and White Oak



**Routed Newels**

Non removable caps  
 Stocked in Red Oak and White Oak



**Blank Newels**

Optional caps available  
 Stocked in Red Oak and White Oak



**Blank Newel Caps**

Available for: 3-1/4" and 5-1/2" blank newels  
 Stocked in Red Oak and White Oak - Sold separately

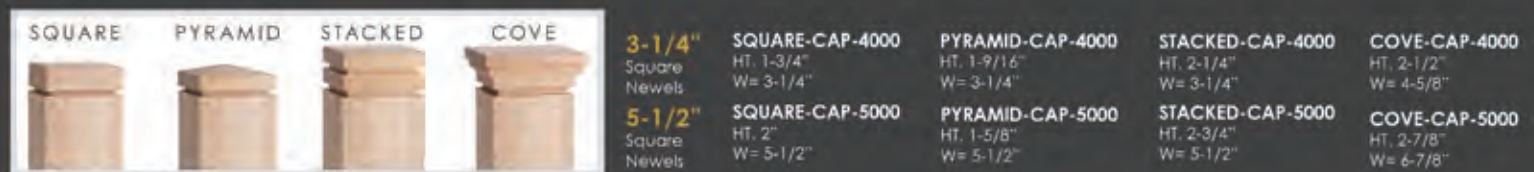

**Newel Bases**

Stocked in Red Oak and White Oak  
 Sold separately.





## Modern Handrail

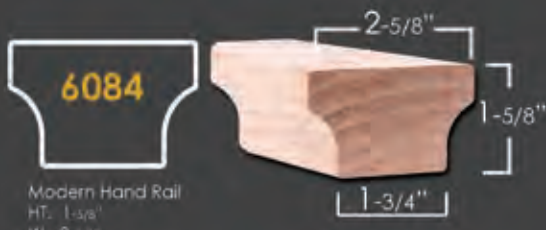

**6084**

Modern Hand Rail  
HT. 1-5/8"  
W. 2-5/8"

**6084** Straight Rail  
**6084-B** Bending Rail  
available in Poplar



**6002**

Modern Hand Rail  
HT. 1-5/8"  
W. 2-3/4"

**6002** Straight Rail  
**6002-B** Bending Rail  
no fittings available  
available in Poplar

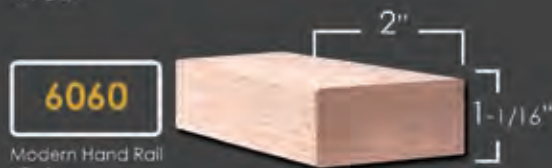

**6060**

Modern Hand Rail  
HT. 1-5/8"  
W. 2"

**6060** Straight Rail  
no fittings available

\* All wood parts stocked in Red Oak and White Oak

## ROUND STAINLESS NEWEL

**HF17.1.2-T**  
Ends: 1-3/16" Rd.  
Height: 47"  
Wt. 5.7 lbs.  
TUBULAR

## ROUND NEWEL

**HF 16.5.11**  
Ends: 1-3/16" Rd.  
Height: 48"  
Wt. 19 lbs.  
SOLID

**HF 16.5.11-T**  
Ends: 1-3/16" Rd.  
Height: 48"  
Wt. 5.7 lbs.  
TUBULAR



(Newels or bars can be cut to length for handrail brackets)

## Wall Mount Handrail Bracket



mounting hardware included



**HF17.4002**  
Stainless Steel(304)  
HT. 2-1/2"  
Base = 1-1/2" x 2"  
Extends 3-1/4" off wall  
ADJUSTABLE

**HFSTB17.4002**  
Satin Black  
HT. 2-1/2"  
Base = 1-1/2" x 2"  
Extends 3-1/4" off wall  
ADJUSTABLE

## Newel Mount Handrail Bracket



mounting hardware included



**HF17.4001**  
Stainless Steel(304)  
HT. 1-3/4"  
Base = 1-1/2" sq.  
ADJUSTABLE

**HFSTB17.4001**  
Satin Black  
HT. 1-3/4"  
Base = 1-1/2" sq.  
ADJUSTABLE

## Cable Gripping Pliers



**HFC18.PLIER**

## Cable Cutter



**HFC18.CUTTER**

## Insert Tube



Length: 1-1/2"  
**HFC18.TUBE**

## Release Key



**HFC18.KEY**

## Cable Cut-off Wheel



**HFC18.WHEEL**

## Lag Bolt Driver



For use with WLN1/8-1  
swageless cable fitting

**DRIVER PL-LAG/R**

## Stainless Cleaner-Protectant



**HFC18.CLEAN**



Ash Grey (shown)



Ash Grey (shown)



16 Satin Black (shown)



Satin Black (shown)

CURATED TRANSITIONAL STYLE

# HARMONY™

## COLLECTION

AVAILABLE EXCLUSIVELY FROM HOF  
ACCEPT NO IMITATIONS

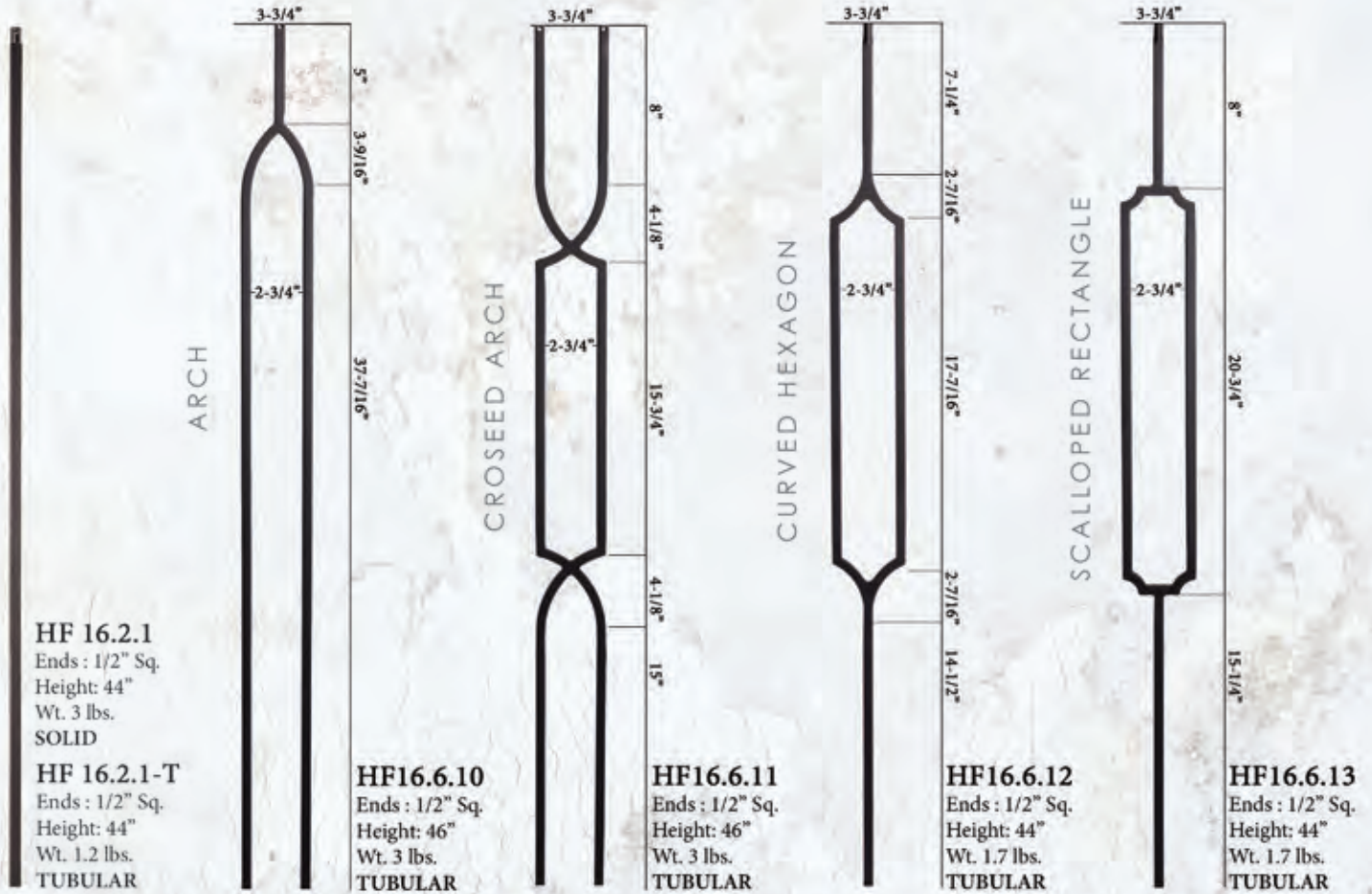

SATIN BLACK (STB)



ASH GREY (AG)

EXCLUSIVE



**HF16.3.9**  
Level Base Collar - CAST IRON  
Base : 1-9/16" Rd. - Height: 3/8" - Wt. .15 lbs.

**HF16.3.60**  
Level Base Collar - ALUMINUM  
Base : 1-9/16" Rd. - Height: 3/8" - Wt. .1 lbs.

EXCLUSIVE



**HF16.3.61** Fits angles up to 40°  
Angled Base Collar - ALUMINUM  
Base : 1-9/16" Rd. - Height: 3/8" - Wt. .1 lbs.



**HF16.3.19**  
Level Base Shoe w/Set Screw - ALUMINUM  
Base : 1-5/16" Sq. - Height: 1" - Wt. .1 lbs.



**HF16.3.2**  
Angle Base Shoe w/Set Screw - ALUMINUM  
Base : 1-5/16" Sq. - Height: 1-7/8" - Wt. .15 lbs.

BALUSTRADE

SOHO™

AVAILABLE EXCLUSIVELY  
FROM HOF  
ACCEPT NO IMITATIONS

ITALY·USA  
DESIGN COLLABORATIVE

PATENT PENDING

# SOHO™ | BALUSTRADE

Customize your style like never before with the latest offering from HOF. Luxurious brass and stainless steel paired with black iron makes a bold statement.



SATIN BLACK (STB)

STAINLESS STEEL (SS)

SATIN BLACK (STB)

BRASS (BR)

## configuration options for your style



## sleeves

## newel mounting kit flange covers

## balusters/newels

**BALUSTER** SATIN BLACK - (Powder coated)  
**BALUSTER HFSTB16.4.1** Diameter: 20mm Rd. Length: 8" Wt. .3 lbs.  
**NEWEL HFSTB16.4.3** Diameter: 35mm Rd. Length: 8" Wt. .75 lbs.

**BALUSTER** BRASS (Satin Polish - Passivated)  
**BALUSTER HF18.4.1** Diameter: 20mm Rd. Length: 8" Wt. .35 lbs.  
**NEWEL HF18.4.3** Diameter: 35 mm Rd. Length: 8" Wt. .75 lbs.

**BALUSTER** STAINLESS STEEL (Satin Polish - 304 Grade)  
**BALUSTER HF17.4.1** Diameter: 20mm Rd. Length: 8" Wt. .3 lbs.  
**NEWEL HF17.4.3** Diameter: 35mm Rd. Length: 8" Wt. .75 lbs.

Fits 1-3/16" Round Newels  
 Diameter: 4.13" Height: .7"



SATIN BLACK

**HFSTB16.4.5**

Also available in Ash Grey.  
 See page 62.



BRASS

**HF18.4.5**



STAINLESS STEEL

**HF17.4.5**

### NEWEL MOUNTING KIT

Fits 1-3/16" Round Newels

**HF16.2.9**



Replacement set screws  
 Satin Black, Brass, Stainless Steel

SATIN BLACK - (Powder coated)

**BALUSTER HFSTB16.8.1** Diameter: 5/8" Rd. Tubular Length: 44" Wt. 1.35 lbs.  
**NEWEL HFSTB16.5.11-T** Diameter: 1-3/16" Rd. Tubular Length: 47" Wt. 4.8 lbs.

BRASS (Satin Polish - Passivated)

**BALUSTER HF18.8.1** Diameter: 5/8" Rd. Tubular Length: 44" Wt. 1.45 lbs.  
**NEWEL HF18.8.3** Diameter: 1-3/16" Rd. Tubular Length: 47" Wt. 5.7 lbs.

STAINLESS STEEL (Satin Polish - 304 Grade)

**BALUSTER HF17.8.1** Diameter: 5/8" Rd. Tubular Length: 44" Wt. 1.2 lbs.  
**NEWEL HF17.1.2-T** Diameter: 1-3/16" Rd. Tubular Length: 47" Wt. 5.7 lbs.

Passivated to minimize tarnishing, use gloves when handling



AVAILABLE  
EXCLUSIVELY  
FROM HOF

ACCEPT  
NO IMITATIONS

Photo courtesy of Homes by Sal Cohen - Bellevue, WA

Satin Black (shown)

**ITALY·USA**  
DESIGN COLLABORATIVE

PATENT PENDING

# FOUNDATION™

BALUSTERS

- TUBULAR
- NO COLLARS OR SHOES REQUIRED
- AFFORDABLE STYLE

**SATIN BLACK**

STB

1" Square (Tubular)

HFSTB16.7.5

Weight: 1.15 lbs.

1/2" Square (Tubular)



36"

8"

1/2"

**ASH GREY**

AG

HFAG16.7.5



**OIL RUBBED BRONZE**

ORB

HFORB16.7.5



Bottom pin for quick installation!



1/2"

1/2" Diameter



Ash Grey (shown)



Photo courtesy of Home Lumber  
New Haven, IN

Satin Black (shown)



Satin Black (shown)

# MEGA<sub>COLLECTION</sub>

Our most popular designs in a grand size



SIZE COMPARISON: Mega 3/4" vs. Standard 1/2"

# MEGA<sub>COLLECTION</sub>

Our most popular designs in a grand size

PERFECT FOR NEW CONSTRUCTION OR REMODEL  
Create mega impact with these grand balusters

- Ideal for large or small staircases
- Perfect for replacing old wood balusters
- Traditional or modern base shoe/collar options



# MEGA SQUARE



## Finishes & Patinas



SATIN BLACK (STB)



ASH GREY (AG)



OIL RUBBED BRONZE (ORB)



**Pintop**  
Diameter: 5/8"  
Height: 3/4"

**Tubular Bar Specifications**  
Superior 18 gauge wall thickness  
(1/20" / 1.27mm)



**HF 16.5.8**  
Ends: 1-3/16" Sq.  
Height: 48"  
Wt. 19 lbs.  
SOLID

**HF 16.5.8-T**  
Ends: 1-3/16" Sq.  
Height: 48"  
Wt. 4.8 lbs.  
TUBULAR

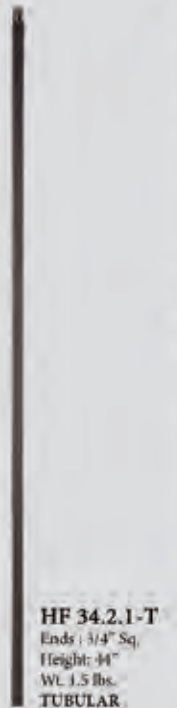

**HF 34.2.1-T**  
Ends: 3/4" Sq.  
Height: 44"  
Wt. 1.5 lbs.  
TUBULAR



**HF 34.1.1-T**  
Ends: 3/4" Sq.  
Height: 44"  
Wt. 1.5 lbs.  
TUBULAR



**HF 34.1.2-T**  
Ends: 3/4" Sq.  
Height: 44"  
Wt. 1.5 lbs.  
TUBULAR



**HF 34.1.3-T**  
Ends: 3/4" Sq.  
Height: 44"  
Wt. 2.45 lbs.  
TUBULAR



**HF 34.1.4-T**  
Ends: 3/4" Sq.  
Height: 44"  
Wt. 3.35 lbs.  
TUBULAR



**HF 34.1.25-T**  
Ends: 3/4" Sq.  
Height: 44"  
Wt. 5.05 lbs.  
TUBULAR



**HF 34.1.34-T**  
Ends: 3/4" Sq.  
Height: 44"  
Wt. 1.75 lbs.  
TUBULAR



**HF 34.1.35-T**  
Ends: 3/4" Sq.  
Height: 44"  
Wt. 2 lbs.  
TUBULAR



**HF 34.6.1**  
Ends: 3/4" Sq.  
Height: 44"  
Wt. 3.25 lbs.  
TUBULAR



**HF 34.6.3**  
Ends: 3/4" Sq.  
Height: 44"  
Wt. 2.35 lbs.  
TUBULAR



EXCLUSIVE

**HF34.3.16**  
Level Base Collar - CAST IRON  
Base: 2" Rd. - Height: 3/8" - Wt. .15 lbs.

**HF34.3.19**  
Level Base Shoe w/Set Screw - ALUMINUM  
Base: 1-7/8" Sq. - Height: 1-9/16" - Wt. .1 lbs.

**HF34.3.2**  
Angle Base Shoe w/Set Screw - ALUMINUM  
Base: 1-7/8" Sq. - Height: 2-7/8" - Wt. .15 lbs.

**HF16.2.3**  
Newel Mounting Kit

For photos and full accessory details see pages 62-63





Oil Rubbed Bronze (shown)

## WENTWORTH | COLLECTION

Inspired by old world English design, Wentworth Collection is an ode to an era of simple craftsmanship and metalsmithing. Hand forged design available in our most popular finishes & patinas.



Satin Clear (shown)



Satin Clear (shown)



Satin Black (shown)



Oil Rubbed Bronze (shown)

# WENTWORTH

ROUND HAND FORGED SQUARE RUSTIC HAMMERED



## Finishes & Patinas



SATIN BLACK  
(STB)



OIL RUBBED  
BRONZE  
(ORB)

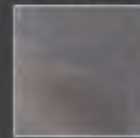

SATIN CLEAR  
(SC)

### ACCESSORIES

Round level base shoes **HF16.3.35**  
 Round angled base shoes **HF16.3.36**  
 Round level base collar(modern) **HF16.3.12**

Square level base shoes **HF16.3.38**  
 Square angled base shoes **HF16.3.39**  
 Square level base collar(modern) **HF16.3.15**

Round newel mounting kit **HF16.3.33**  
 Square newel mounting kit **HF16.3.31**

Photos: J.  
 Photos: N.  
 Photos: Q.

Photos: C.  
 Photos: G.  
 Photos: P.

Photos: U.  
 Photos: T.

For photos and full accessory details see pages 62-63

 <p style="text-align: center;"><b>NEWEL</b></p> <p style="text-align: center;">47"</p> <p><b>HF 1.1.22</b>              Ends : 1" Rd.              Height: 47"              Wt. 18 lbs.  <b>SOLID</b></p>	 <p style="text-align: center;"><b>NEWEL</b></p> <p style="text-align: center;">44"</p> <p><b>HF 3.1.1</b>              Ends : 5/8" Rd.              Height: 44"              Wt. 3.6 lbs.  <b>SOLID</b></p>	 <p style="text-align: center;"><b>NEWEL</b></p> <p style="text-align: center;">9-1/2" 2" 7" 2" 7" 2" 14-1/2"</p> <p><b>HF 3.1.2</b>              Ends : 5/8" Rd.              Height: 44"              Wt. 3.58 lbs.  <b>SOLID</b></p>	 <p style="text-align: center;"><b>NEWEL</b></p> <p style="text-align: center;">47"</p> <p><b>HF 1.1.23</b>              Ends : 1" Sq.              Height: 47"              Wt. 18 lbs.  <b>SOLID</b></p>	 <p style="text-align: center;"><b>NEWEL</b></p> <p style="text-align: center;">44"</p> <p><b>HF 3.2.1</b>              Ends : 5/8" Sq.              Height: 44"              Wt. 4.28 lbs.  <b>SOLID</b></p>	 <p style="text-align: center;"><b>NEWEL</b></p> <p style="text-align: center;">9-1/2" 1-1/2" 7-3/4" 1-1/2" 7-3/4" 1-1/2" 14-1/2"</p> <p><b>HF 3.2.2</b>              Ends : 5/8" Sq.              Height: 44"              Wt. 5.2 lbs.  <b>SOLID</b></p>
---	---	--	--	--	---

Hand forged product, variance in specifications may occur.



Satin Black (shown)



Oil Rubbed Bronze (shown)

# AALTO

Ash Grey (shown)

Satin Black (shown)

Our Aalto collection is a compliment to the modern design aesthetic. Adorn any space with the clean lines and open detail of these modern balusters and panels.



Satin Black (shown)



Ash Grey (shown)



Satin Black (shown)



Ash Grey (shown)



Satin Black (shown)



Ash Grey (shown)

# AALTO

SQUARE



## Finishes & Patinas



SATIN BLACK  
(STB)

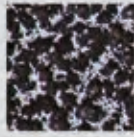

SILVER VEIN  
(SP)



ASH GREY  
(AG)



DORADO GOLD  
(GD)

	NEWELS	HF16.5.8	HF16.5.8-T	BALUSTERS	HF16.2.1	HF16.2.1-T	HF16.2.1-50	HF16.1.30	HF16.1.30-T	HF16.1.31	HF16.1.31-T	HF16.1.32	HF16.1.32-T	HF16.6.1	HF16.6.2	HF16.6.3	HF16.6.4	HF16.6.5	HF16.6.7	HF16.6.8	HF16.6.9	HF9.4.11	
STB		•			•	•	•	•		•		•		•	•	•	•	•	•	•	•	•	•
SP		•			•	•																	
AG			•		•	•			•	•		•	•	•	•	•	•	•	•	•	•	•	•
GD		•			•									•		•				•			

### ACCESSORIES

Level base shoes

HF16.3.1, HF16.3.19

Level base collars

HF16.3.4, HF16.3.5,

Angled base shoes

HF16.3.2, HF16.3.30

Adjustable level base shoes

HF16.3.44, HF16.3.46

Adjustable angle base shoes

HF16.3.45, HF16.3.47

Level base collars(modern)

HF16.3.9, HF16.3.60

Angled base collars(modern)

HF16.3.61

Newel mounting kit

HF16.2.3

Photos: A. A.

Photos: D. H.

Photos: E. G.

Photos: R.

Photos: S.

Photos: P. O2 **NEW**

Photos: O3 **NEW**

Photos: T.

For photos and full accessory details see pages 62-63



Satin Black (shown)





**HF 16.5.8**  
Ends: 1-3/16" Sq.  
Height: 48"  
Wt. 19 lbs.  
SOLID



**HF 16.2.1**  
Ends: 1/2" Sq.  
Height: 44"  
Wt. 3 lbs.  
SOLID



**HF 16.1.30**  
Ends: 1/2" Sq.  
Height: 44"  
Wt. 3.4 lbs.  
SOLID



**HF 16.1.31**  
Ends: 1/2" Sq.  
Height: 44"  
Wt. 3.6 lbs.  
SOLID



**HF 16.1.32**  
Ends: 1/2" Sq.  
Height: 44"  
Wt. 10 lbs.  
SOLID



**HF 16.6.1**  
Ends: 1/2" Sq.  
Height: 44"  
Wt. 2.5 lbs.  
TUBULAR

**HF 16.5.8-T**  
Ends: 1-3/16" Sq.  
Height: 48"  
Wt. 4.8 lbs.  
TUBULAR

**HF 16.2.1-T**  
Ends: 1/2" Sq.  
Height: 44"  
Wt. 1.2 lbs.  
TUBULAR

**HF 16.1.30-T**  
Ends: 1/2" Sq.  
Height: 44"  
Wt. 1.6 lbs.  
TUBULAR

**HF 16.1.31-T**  
Ends: 1/2" Sq.  
Height: 44"  
Wt. 1.75 lbs.  
TUBULAR

**HF 16.1.32-T**  
Ends: 1/2" Sq.  
Height: 44"  
Wt. 5 lbs.  
TUBULAR



**HF 16.6.8**  
Ends: 1/2" Sq.  
Height: 44"  
Wt. 1.25 lbs.  
TUBULAR



**HF 16.6.9**  
Ends: 1/2" Sq.  
Height: 44"  
Wt. 1.6 lbs.  
TUBULAR



**HF 16.6.7**  
Ends: 1/2" Sq.  
Height: 44"  
Wt. 1.6 lbs.  
TUBULAR



**HF 16.6.2**  
Ends: 1/2" Sq.  
Height: 44"  
Wt. 1.6 lbs.  
TUBULAR



**HF 16.6.3**  
Ends: 1/2" Sq.  
Height: 44"  
Wt. 1.7 lbs.  
TUBULAR



**HF 16.6.4**  
Ends: 1/2" Sq.  
Height: 44"  
Wt. 1.7 lbs.  
TUBULAR



**HF 16.6.5**  
Ends: 1/2" Sq.  
Height: 44"  
Wt. 1.3 lbs.  
TUBULAR

fits all angles up to 40 degrees



**HF 9.4.11**  
Ends: 1/2" Sq.  
Height: 46"  
Wt. 4.5 lbs.  
TUBULAR (Rake)



Satin Clear (shown)

Oil Rubbed Bronze (shown)

The craftsmanship in these hand-forged balusters exude character and beauty nearly impossible to duplicate. Our Tuscan series is available in both round forged and square hammered profiles. Bring the rustic charm of old world Italy into your home with this unique series.

# TUSCAN

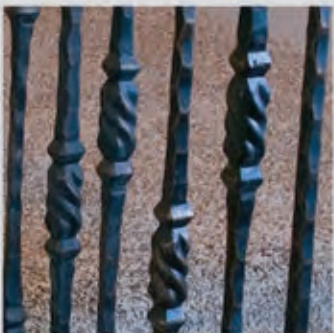

Satin Clear (shown)



Oil Rubbed Bronze (shown)



# TUSCAN

ROUND HAND FORGED



## Finishes & Patinas



SATIN BLACK (STB)

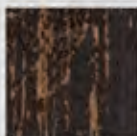

OIL RUBBED BRONZE (ORB)



SATIN CLEAR (SC)

	NEWELS	HF1.1.22	HF1.1.9	HF1.1.21	BALUSTERS	HF2.9.21	HF2.1.5	HF2.1.6	HF2.1.7	HF2.1.9	HF2.1.8	HF2.1.11	HF2.6.8	HF2.6.9	HF2.6.7	HF2.10.2	HF2.10.4	HF2.10.3
STB		•	•	•		•	•	•	•	•	•	•	•	•	•	•	•	•
ORB						•	•	•	•	•	•	•	•	•	•	•	•	•
SC		•	•			•							•	•	•	•	•	•

### ACCESSORIES

- Level base shoes
- Level base collars
- Angled base shoes
- Adjustable level base shoes
- Adjustable angle base shoes
- Level base collars(modern)

- HF16.3.26
- HF16.3.40, HF16.3.43
- HF16.3.27
- HF16.3.44, HF16.3.46
- HF16.3.45, HF16.3.47
- HF16.3.10

- Photos: J.
- Photos: K. O.
- Photos: N.
- Photos: R.
- Photos: S.
- Photos: Q. **NEW**

For photos and full accessory details see pages 62-63



**HF 1.1.22**  
Ends : 1" Rd.  
Height: 47-1/4"  
Wt. 18 lbs.



**HF 1.1.9**  
Ends : 1" Rd.  
Height: 47-1/4"  
Wt. 18 lbs.



**HF 1.1.21**  
Ends : 1" Rd.  
Tapered  
Height: 47-1/4"  
Wt. 18 lbs.



**HF 2.1.5**  
Ends : 9/16" Rd.  
Height: 44"  
Wt. 2.5 lbs.



**HF 2.1.6**  
Ends : 9/16" Rd.  
Height: 44"  
Wt. 4.2 lbs.



**HF 2.1.7**  
Ends : 9/16" Rd.  
Height: 44"  
Wt. 3 lbs.



**HF 2.1.9**  
Ends : 9/16" Rd.  
Height: 44"  
Wt. 2.4 lbs.



**HF 2.1.8**  
Ends : 9/16" Rd.  
Height: 44"  
Wt. 4.2 lbs.



**HF 2.1.11**  
Ends : 9/16" Rd.  
Height: 44"  
Wt. 3 lbs.



**HF 2.6.8**  
Ends : 9/16" Rd.  
Tapered  
Height: 44"  
Wt. 3.2 lbs.

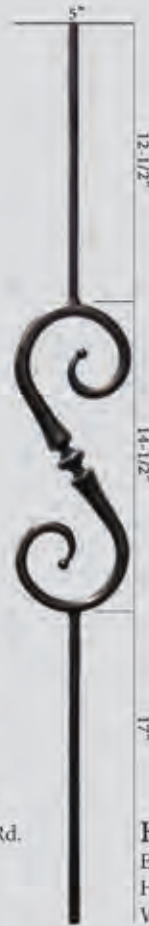

**HF 2.6.9**  
Ends : 9/16" Rd.  
Height: 44"  
Wt. 4.2 lbs.



**HF 2.6.7**  
Ends : 9/16" Rd.  
Tapered  
Height: 44"  
Wt. 3.8 lbs.



**HF 2.9.21**  
Ends : 9/16" Rd.  
Height: 44"  
Wt. 2.4 lbs.



**HF 2.10.2**  
Ends : 9/16" Rd.  
Height: 44"  
Wt. 3.2 lbs.



**HF 2.10.4**  
Ends : 9/16" Rd.  
Height: 44"  
Wt. 4.2 lbs.



**HF 2.10.3**  
Ends : 9/16" Rd.  
Height: 44"  
Wt. 3.6 lbs.

# TUSCAN

SQUARE HAND HAMMERED



## Finishes & Patinas



SATTIN BLACK  
(STB)



OIL RUBBED  
BRONZE  
(ORB)

	NEWELS	HF1.1.14-T	BALUSTERS	HF2.9.12	HF2.9.11	HF2.9.13	HF2.9.3	HF2.9.4	HF2.9.8	HF2.9.5	HF2.9.6	HF2.1.2	HF2.1.1	HF2.9.20	HF2.9.20-T	HF2.9.28	HF2.9.28-T	HF2.9.27	HF2.9.26	HF2.9.26-T	HF2.9.29	HF2.9.36	HF2.9.37	
STB		•		•	•	•	•	•	•	•	•	•	•	•	•	•	•	•	•	•	•	•	•	•
ORB				•	•	•	•	•	•	•	•	•	•	•	•	•	•	•	•	•	•	•	•	•

### ACCESSORIES

- Level base shoes **HF16.3.25**
- Level base collars **HF16.3.41, HF16.3.42**
- Angled base shoes **HF16.3.28**
- Adjustable level base shoes **HF16.3.44, HF16.3.46**
- Adjustable angle base shoes **HF16.3.45, HF16.3.47**
- Level base collars(modern) **HF16.3.11**
- Newel mounting kit **HF16.3.31**

- Photos: C.
- Photos: D. H.
- Photos: G.
- Photos: R.
- Photos: S.
- Photos: P. **NEW**
- Photos: T.

For photos and full accessory details see pages 62-63



NEWEL

47-1/4"

**HF 1.1.14-T**  
Ends : 1" Sq.  
Height: 47-1/4"  
Wt. 2.30 lbs.  
TUBULAR



**HF 2.9.20**  
Ends : 9/16" Sq.  
Height: 44"  
Wt. 3 lbs.  
SOLID  
**HF 2.9.20-T**  
Ends : 9/16" Sq.  
Height: 44"  
Wt. 1.05 lbs.  
TUBULAR



**HF 2.9.12**  
Ends : 9/16" Sq.  
Tapered  
Height: 44"  
Wt. 3.8 lbs.



**HF 2.9.11**  
Ends : 9/16" Sq.  
Height: 44"  
Wt. 5 lbs.



**HF 2.9.13**  
Ends : 9/16" Sq.  
Tapered  
Height: 44"  
Wt. 5.5 lbs.

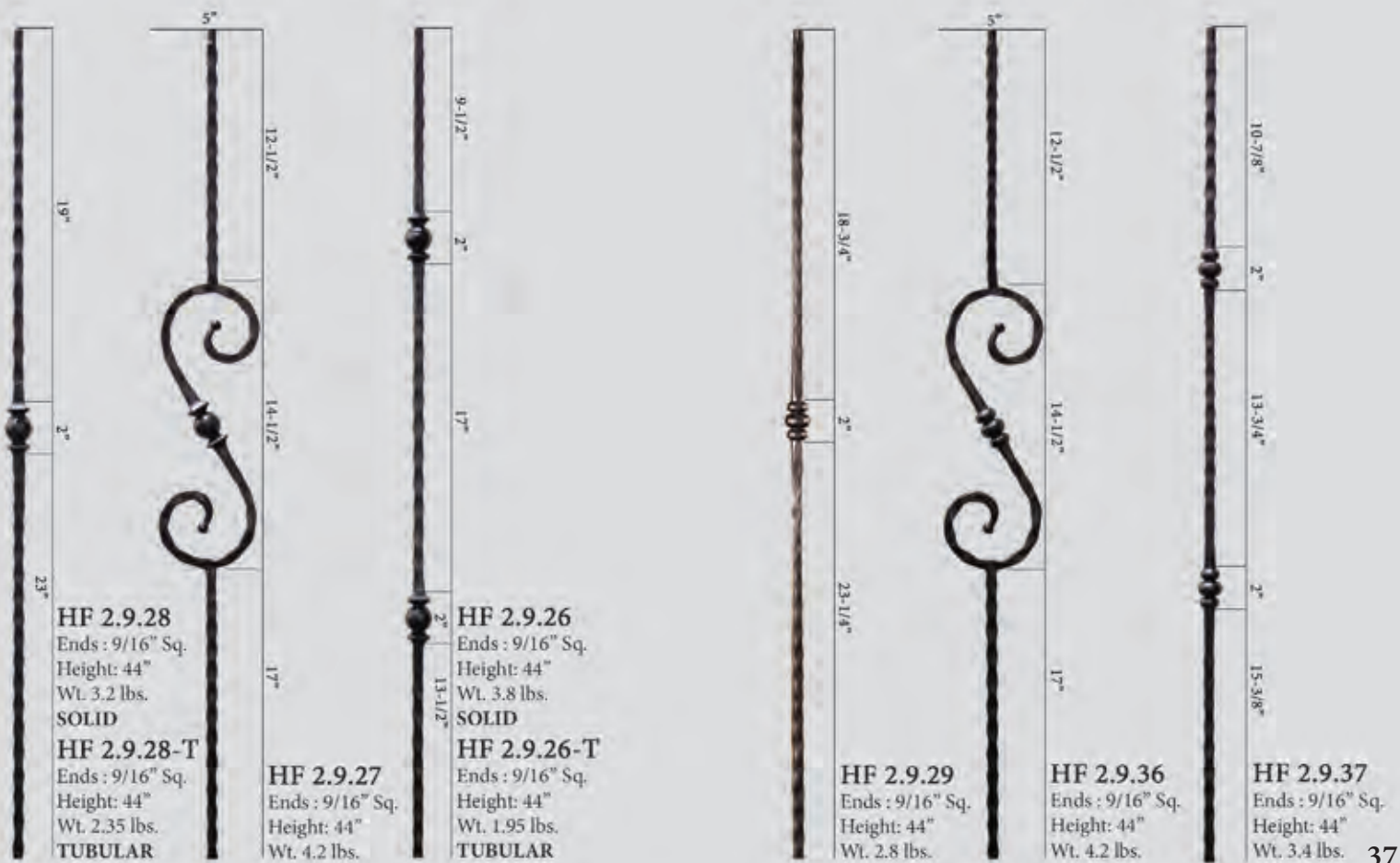

# MONTE CARLO



Oil Rubbed Bronze (shown)

Drawing inspiration from the great Roman columns, the Monte Carlo series stands alone in style and elegance. The robust designs compliment the prominence of even the grandest estates. The intricately cast components are highlighted by the Oil Rubbed Bronze patina.

Satin Black (shown)





# MONTE CARLO

ROUND



## Finishes & Patinas



SATIN BLACK  
(STB)

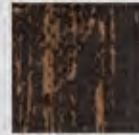

OIL RUBBED  
BRONZE  
(ORB)



NEWEL

**HF 18.1.1-T**  
Ends : 1-3/16" Rd.  
Height: 48"  
Wt. 18.55 lbs.  
**TUBULAR**

\*Middle section is hollow cast iron,  
ends are hollow cast steel



**HF 18.2.1-T**  
Ends : 5/8" Rd.  
Height: 44"  
Wt. 1.75 lbs.  
**TUBULAR**

\*Middle section is hollow cast aluminum, ends are hollow cast steel



**HF 18.2.2-T**  
Ends : 5/8" Rd.  
Height: 44"  
Wt. 1.50 lbs.  
**TUBULAR**

### ACCESSORIES

- Level base shoes
- Angled base shoes
- Level base collars(modern)
- Newel mounting kit

- HF16.3.50**
- HF16.3.51**
- HF16.3.12**
- HF16.3.14**

- Photos: I.
- Photos: M.
- Photos: Q. **NFW**
- Photos: U.

For photos and full accessory details see pages 62-63



# DESIGNER



Photo courtesy of Fix Carpentry - Parker, CO

Satin Black (shown)

The designer series offers an upgraded look at an affordable price for homebuilders and homeowners alike. These hollow balusters are offered in square bar stock and compliment a wide range of architectural styles.

Oil Rubbed Bronze (shown)



Satin Black (shown)

# DESIGNER TUBULAR

SQUARE



## Finishes & Patinas



SATIN BLACK  
(STB)



OIL RUBBED  
BRONZE  
(ORB)



**HF 16.8.6**  
Ends : 5/8" Sq.  
Height: 44"  
Wt. 2 lbs.  
TUBULAR



**HF 16.8.10**  
Ends : 5/8" Sq.  
Height: 44"  
Wt. 2 lbs.  
TUBULAR



**HF 16.8.11**  
Ends : 5/8" Sq.  
Height: 44"  
Wt. 2 lbs.  
TUBULAR



**HF 16.8.8**  
Ends : 5/8" Sq.  
Height: 44"  
Wt. 3 lbs.  
TUBULAR



**HF 16.8.9**  
Ends : 5/8" Sq.  
Height: 44"  
Wt. 4 lbs.  
TUBULAR

### ACCESSORIES

- Level base shoes
- Angled base shoes
- Level base collars(modern)

- HF16.3.38**
- HF16.3.39**
- HF16.3.15**

- Photos: J. C.
- Photos: N. G.
- Photos: P. NEW

For photos and full accessory details see pages 62-63



# STAINLESS STEEL



Stainless steel is a mainstay in the modern and contemporary home decor market. The simple, honest lines of this profile is the perfect compliment to your urban dwelling. Now, offered in a more affordable tubular style for the budget savvy buyer.

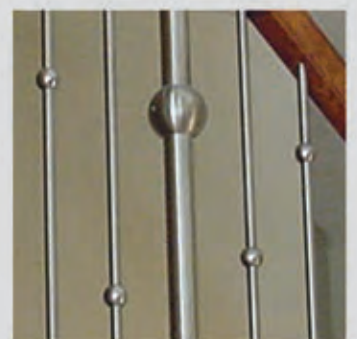

# STAINLESS STEEL



ROUND



STAINLESS STEEL



NEWEL

**HF17.1.2**  
Ends : 1-3/16" Rd.  
Height: 47"  
Wt. 18 lbs.  
**SOLID**

**HF17.1.2-T**  
Ends : 1-3/16" Rd.  
Height: 47"  
Wt. 5.7 lbs.  
**TUBULAR**



NEWEL

**HF17.12.1-T**  
Ends : 1-3/16" Rd.  
Height: 47"  
Wt. 5.7 lbs.  
**TUBULAR**



**HF17.11.5**  
Ends : 9/16" Rd.  
Height: 44"  
Wt. 3.5 lbs.  
**SOLID**

**HF17.11.5-T**  
Ends : 9/16" Rd.  
Height: 44"  
Wt. 1.25 lbs.  
**TUBULAR**



**HF17.11.21-T**  
Ends : 9/16" Rd.  
Height: 44"  
Wt. 1.25 lbs.  
**TUBULAR**



**HF17.11.23-T**  
Ends : 9/16" Rd.  
Height: 44"  
Wt. 1.25 lbs.  
**TUBULAR**

## ACCESSORIES

Level base collar  
Newel mounting kit

**HF17.11.22**  
**HF17.2.3**

Photos: L.  
Photos: V.

For photos and full accessory details see pages 62-63



# GOTHIC



Satin Black (shown)

The inspiration for our Gothic series was the timeless ironwork featured in many European castles and estates. These prominent designs will compliment old world hardware and fixtures found throughout many homes today.



Oil Rubbed Copper (shown)

# GOTHIC

SQUARE FACE HAMMERED



## Finishes & Patinas



SATIN BLACK  
(STB)



OIL RUBBED  
BRONZE  
(ORB)



OIL RUBBED  
COPPER  
(ORC)



STB  
(ONLY)

**HF 16.5.6**  
Ends : 1-3/16" Sq.  
Height: 48"  
Wt. 22 lbs.



**HF 16.1.7**  
Ends : 9/16" Sq.  
Height: 44"  
Wt. 4 lbs.  
**SOLID**



**HF 16.5.2**  
Ends : 9/16" Sq.  
Height: 44"  
Wt. 3.5 lbs.  
**SOLID**



**HF 16.1.8**  
Ends : 9/16" Sq.  
Height: 44"  
Wt. 3.8 lbs.  
**SOLID**



**HF 16.1.9**  
Ends : 9/16" Sq.  
Height: 44"  
Wt. 4.5 lbs.  
**SOLID**

## ACCESSORIES

- Level base shoes
- Level base collars
- Angled base shoes
- Adjustable level base shoes
- Adjustable angle base shoes
- Level base collars(modern)
- Newel mounting kit

- HF16.3.3, HF16.3.20, HF16.3.25**
- HF16.3.41, HF16.3.42**
- HF16.3.17, HF16.3.28**
- HF16.3.44, HF16.3.46**
- HF16.3.45, HF16.3.47**
- HF16.3.11**
- HF16.2.3**

- Photos: A. A. C.
- Photos: D. H.
- Photos: E. G.
- Photos: R.
- Photos: S.
- Photos: P. **NEW**
- Photos: T.

For photos and full accessory details see pages 62-63





Safin Black (shown)

The style of this collection provides a sleek appearance that strikes a perfect balance between traditional and contemporary.

Safin Black (shown)



# ROUND



Oil Rubbed Bronze, Satin Black (shown)



Oil Rubbed Bronze (shown)



Satin Black (shown)



Satin Black (shown)

# ROUND

ROUND SMOOTH



## Finishes & Patinas



SATIN BLACK  
(STB)



OIL RUBBED  
BRONZE  
(ORB)



ASH GREY  
(AG)

	NEWELS	HF16.5.11	HF16.5.11-T	HF1.1.19	BALUSTERS	HF16.2.2	HF16.1.17	HF16.1.18	HF16.1.19	HF16.1.20	HF16.1.25-R	HF2.11.3	HF2.11.3-T	HF2.11.4	HF2.11.4-T	HF2.11.16	HF2.11.16-T	HF16.8.1	HF16.8.12	HF16.8.13	
STB		•		•		•	•	•	•	•	•	•	•	•	•	•	•	•	•	•	•
ORB													•		•		•				
AG		•																			



NEWEL

**HF 16.5.11**  
Ends : 1-3/16" Rd.  
Height: 48"  
Wt. 19 lbs.  
SOLID

**HF 16.5.11-T**  
Ends : 1-3/16" Rd.  
Height: 48"  
Wt. 5.7 lbs.  
TUBULAR



**HF 16.2.2**  
Ends : 9/16" Rd.  
Height: 44"  
Wt. 2.7 lbs.



**HF 16.1.17**  
Ends : 9/16" Rd.  
Height: 44"  
Wt. 2.7 lbs.



**HF 16.1.18**  
Ends : 9/16" Rd.  
Height: 44"  
Wt. 3 lbs.



**HF 16.1.19**  
Ends : 9/16" Rd.  
Height: 44"  
Wt. 4 lbs.



**HF 16.1.20**  
Ends : 9/16" Rd.  
Height: 44"  
Wt. 5 lbs.



### ACCESSORIES

- Level base shoes
- Level base collars
- Angled base shoes
- Adjustable level base shoes
- Adjustable angle base shoes
- Level base shoe, fits 5/8"
- Angled base shoe, fits 5/8"
- Level base collars(modern)
- Newel mounting kit

- HF16.3.13, HF16.3.26**
- HF16.3.40, HF16.3.43**
- HF16.3.16, HF16.3.27**
- HF16.3.44, HF16.3.46**
- HF16.3.45, HF16.3.47**
- HF16.3.35**
- HF16.3.36**
- HF16.3.10, HF16.3.12**
- HF16.3.14, HF16.3.33, HF16.2.9**

- Photos: L. J.
- Photos: K. O.
- Photos: M. N.
- Photos: R.
- Photos: S.
- Photos: J.
- Photos: N.
- Photos: G.
- Photos: U.

For photos and full accessory details see pages 62-63



Ash Grey (shown)

The endless baluster combinations in this series offers a match for your individual taste and style. These balusters compliment our Scroll, Twist and Ribbon series.

Ash Grey (shown)

VERSATILE



Satin Black (shown)

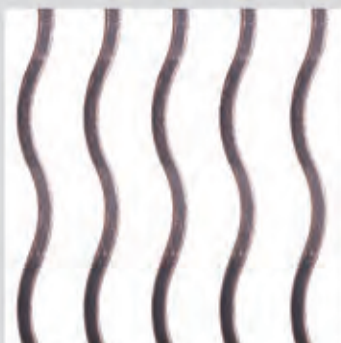

Oil Rubbed Bronze (shown)



# VERSATILE SQUARE



## Finishes & Patinas



SATIN BLACK  
(STB)



COPPER VEIN  
(CV)



OIL-RUBBED  
BRONZE  
(ORB)



OIL-RUBBED  
COPPER  
(ORC)



ASH GREY  
(AG)

	NEWELS	HF16.5.8	HF16.5.8-T	HF16.5.9	BALUSTERS	HF16.2.1	HF16.2.1-T	HF16.2.1-50	HF16.1.34	HF16.1.34-T	HF16.1.35	HF16.1.35-T	HF16.1.45	HF16.1.45-T	HF2.10.1	HF2.2.3	HF16.1.25	HF16.1.25-T	HF16.1.25-S	
STB		•		•		•	•	•	•	•	•	•	•	•	•	•	•	•	•	•
AG			•				•			•		•						•	•	
CV						•	•			•		•					•	•		
ORB		•				•	•		•	•	•	•			•	•	•	•	•	•
ORC		•				•	•		•	•	•	•			•	•	•	•	•	•



**HF 16.5.8**  
Ends : 1-3/16" Sq.  
Height: 48"  
Wt. 19 lbs.  
SOLID



**HF 16.5.9**  
Ends : 1-3/16" Sq.  
Height: 48"  
Wt. 20 lbs.  
SOLID



**HF 16.2.1**  
Ends : 1/2" Sq.  
Height: 44"  
Wt. 3 lbs.  
SOLID

**HF 16.2.1-T**  
Ends : 1/2" Sq.  
Height: 44"  
Wt. 1.2 lbs.  
TUBULAR

**HF 16.2.1-50**  
Ends : 1/2" Sq.  
Height: 50"  
Wt. 3.2 lbs.  
SOLID



**HF 16.1.34**  
Ends : 1/2" Sq.  
Height: 44"  
Wt. 4 lbs.  
SOLID

**HF 16.1.34-T**  
Ends : 1/2" Sq.  
Height: 44"  
Wt. 1.35 lbs.  
TUBULAR



**HF 16.1.35**  
Ends : 1/2" Sq.  
Height: 44"  
Wt. 3.5 lbs.  
SOLID

**HF 16.1.35-T**  
Ends : 1/2" Sq.  
Height: 44"  
Wt. 1.5 lbs.  
TUBULAR



**HF 16.1.45**  
Ends : 1/2" Sq.  
Height: 44"  
Wt. 4 lbs.  
SOLID

**HF 16.1.45-T**  
Ends : 1/2" Sq.  
Height: 44"  
Wt. 1.55 lbs.  
TUBULAR



**HF 2.10.1**  
Ends : 1/2" Sq.  
Height: 44"  
Wt. 4.2 lbs.



**HF 2.2.3**  
Ends : 1/2" Sq.  
Height: 44"  
Wt. 3 lbs.



**HF 16.1.25**  
Ends : 1/2" Sq.  
Height: 44"  
Wt. 5.2 lbs.  
SOLID

**HF 16.1.25-T**  
Ends : 1/2" Sq.  
Height: 44"  
Wt. 3.85 lbs.  
TUBULAR



**HF 16.1.25-S**  
Ends : 1/2" Sq.  
Height: 44"  
Wt. 5.2 lbs.

## ACCESSORIES

- Level base shoes
- Level base collars
- Angled base shoes
- Adjustable level base shoes
- Adjustable angle base shoes
- Level base collars(modern)
- Angled base collars(modern)
- Versatile style knuckle
- Newel mounting kit

- HF16.3.1, HF16.3.19, HF16.3.29**
- HF16.3.4, HF16.3.5,**
- HF16.3.2, HF16.3.30**
- HF16.3.44, HF16.3.46**
- HF16.3.45, HF16.3.47**
- HF16.3.9, HF16.3.60**
- HF16.3.61**
- HF16.5.1**
- HF16.2.3**

- Photos: A. A. C.
- Photos: D. H.
- Photos: E. G.
- Photos: R.
- Photos: S.
- Photos: P. O2 **NEW**
- Photos: O3 **NEW**
- Photos: F.
- Photos: T.

For photos and full accessory details see pages 62-63





Satin Black (shown)

The ribbon style twist in this series pairs nicely with balusters from the Scroll and Versatile series. The ribbon is accented nicely by the Oil Rubbed Bronze patina as well as the Copper Vein finish.

Satin Black (shown)



RIBBON



# RIBBON SQUARE



# Finishes & Patinas



SATIN BLACK  
(STB)



NEWEL

**HF 16.5.7**  
Ends : 1-3/16" Sq.  
Height: 48"  
Wt. 19 lbs.



**HF 16.1.5**  
Ends : 1/2" Sq.  
Height: 44"  
Wt. 3.2 lbs.



**HF 16.1.6**  
Ends : 1/2" Sq.  
Height: 44"  
Wt. 3 lbs.



**HF 16.3.6**  
Ends : 1/2" Sq.  
Height: 44"  
Wt. 3.2 lbs.

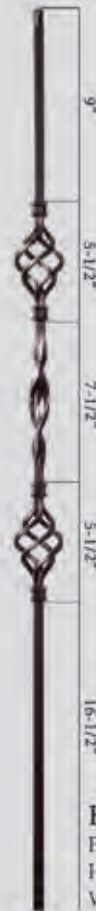

**HF 16.3.7**  
Ends : 1/2" Sq.  
Height: 44"  
Wt. 4 lbs.



**HF 16.1.10**  
 Ends: 1/2" Sq.  
 Height: 44"  
 Wt. 3.6 lbs.



**HF 16.1.11**  
 Ends: 1/2" Sq.  
 Height: 44"  
 Wt. 4.1 lbs.

**ACCESSORIES**

- Level base shoes
- Level base collars
- Angled base shoes
- Adjustable level base shoes
- Adjustable angle base shoes
- Level base collars(modern)
- Angled base collars(modern)
- Versatile style knuckle
- Newel mounting kit

- HF16.3.1, HF16.3.19, HF16.3.29**
- HF16.3.4, HF16.3.5,**
- HF16.3.2, HF16.3.30**
- HF16.3.44, HF16.3.46**
- HF16.3.45, HF16.3.47**
- HF16.3.9, HF16.3.60**
- HF16.3.61**
- HF16.5.1**
- HF16.2.3**

- Photos: A. A. C.
- Photos: D. H.
- Photos: E. G.
- Photos: R.
- Photos: S.
- Photos: P. O2 **NEW**
- Photos: O3 **NEW**
- Photos: F.
- Photos: T.

For photos and full accessory details see pages 62-63





# TWIST

Satin Black (shown)

This popular twist and basket design is a mainstay featured in many new homes. These balusters and newels are offered in an extensive range of finishes and patinas. They combine seamlessly with profiles from the Versatile series.

Oil Rubbed Copper (shown)



Satin Black (shown)

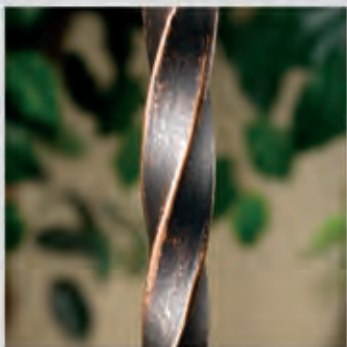

Oil Rubbed Bronze (shown)



Ash Grey (shown)

# TWIST SQUARE



## Finishes & Patinas



	NEWELS	HF16.5.4	HF16.5.4-T	HF16.5.5	HF16.5.5-T	BALUSTERS	HF16.1.1	HF16.1.1-T	HF16.1.2	HF16.1.2-T	HF16.1.3	HF16.1.3-T	HF16.1.4	HF16.1.4-T	HF16.1.21	HF16.1.21-T	HF16.1.16	HF16.1.41
STB		•		•			•	•	•	•	•	•	•	•	•	•	•	•
AG			•		•													
CV							•	•	•	•	•	•	•	•	•	•		
ORB							•	•	•	•	•	•	•	•	•	•		
ORC							•	•	•	•	•	•	•	•	•	•		

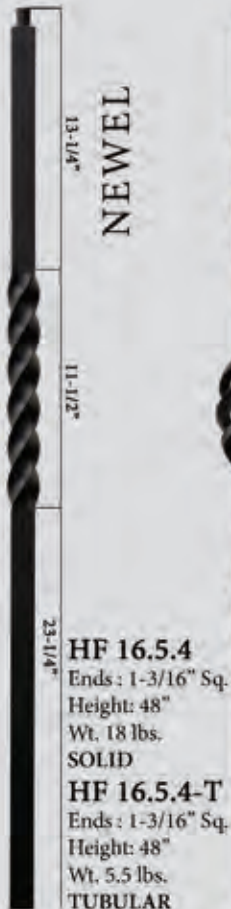

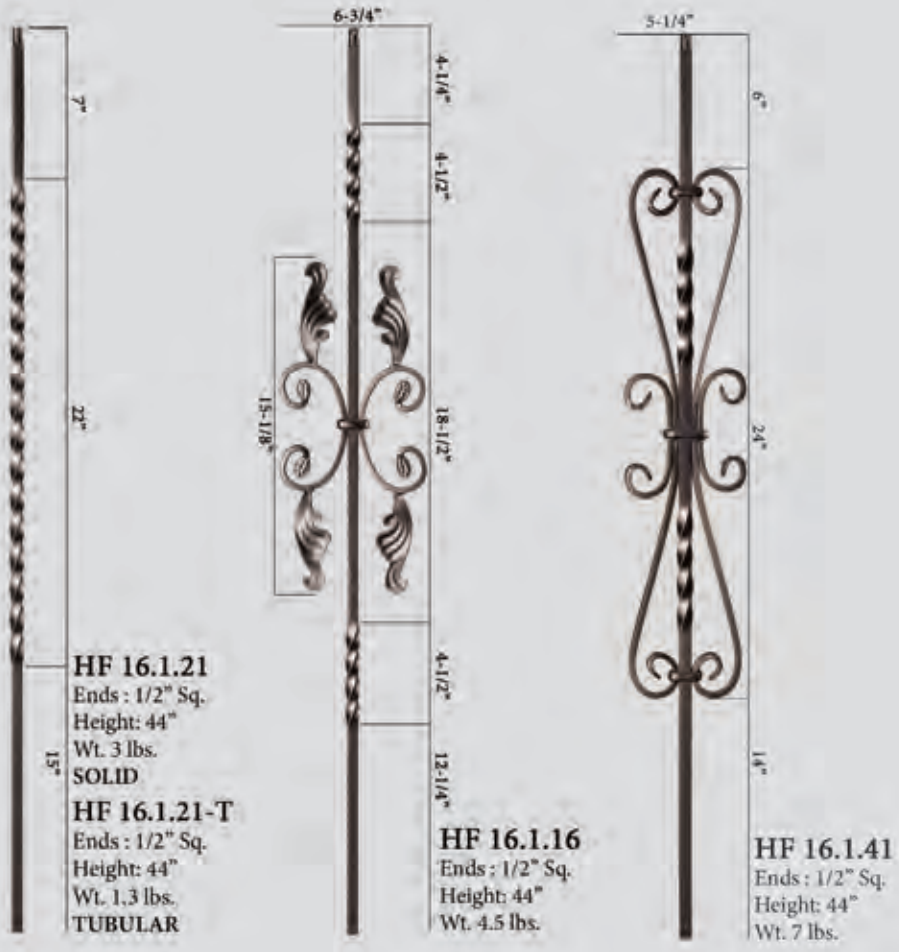

**ACCESSORIES**

- Level base shoes
- Level base collars
- Angled base shoes
- Adjustable level base shoes
- Adjustable angle base shoes
- Level base collars(modern)
- Angled base collars(modern)
- Versatile style knuckle
- Newel mounting kit

- HF16.3.1, HF16.3.19, HF16.3.29**
- HF16.3.4, HF16.3.5,**
- HF16.3.2, HF16.3.30**
- HF16.3.44, HF16.3.46**
- HF16.3.45, HF16.3.47**
- HF16.3.9, HF16.3.60**
- HF16.3.61**
- HF16.5.1**
- HF16.2.3**

- Photos: A. A. C.
- Photos: D. H.
- Photos: E. G.
- Photos: R.
- Photos: S.
- Photos: P. O2 **NEW**
- Photos: O3 **NEW**
- Photos: F.
- Photos: T.

For photos and full accessory details see pages 62-63



Photo	Part #	Description	ACCESSORY SPECIFICATIONS					STB	AG	CV	ORB	ORC	SC	GD
<b>1/2" Square Baluster Accessories</b>														
A.	HF16.3.1	Level base shoe, fits 1/2" square balusters, 1-5/16" square base, aluminum					•		•		•			
A.	HF16.3.19	Level base shoe with set screw, fits 1/2" square balusters, 1-5/16" square base, aluminum					•	•	•	•	•		•	
E.	HF16.3.2	Angled base shoe with set screw, fits 1/2" square balusters, 1-5/16" base, aluminum					•	•	•	•	•		•	
B.	HF16.3.21	Level base shoe with screw mount, fits 1/2" square balusters, 1-9/16" square base, aluminum					•		•					
F.	HF16.5.1	Versatile style knuckle with set screw, fits 1/2" square balusters, 1-7/16" square, aluminum					•		•	•	•			
C.	HF16.3.29	Oil Rubbed Bronze, level base shoe with set screw, fits 1/2" square balusters, 1-1/4" square base, cast iron					•			•				
G.	HF16.3.30	Oil Rubbed Bronze, angled base shoe with set screw, fits 1/2" square balusters, 1-1/4" base, cast iron					•				•			
D.	HF16.3.4	Level base collar, fits 1/2" square balusters, 2" square base, aluminum					•		•	•	•			
H.	HF16.3.5	Level base collar, fits 1/2" square balusters, 1-15/16" round base, aluminum, (ORB - cast iron)					•		•	•	•			
P.	HF16.3.9	Level base collar, fits 1/2" square balusters, 1-9/16" round base, cast iron						•	•	•			•	
O2.	HF16.3.60	Level base collar, fits 1/2" square balusters, 1-9/16" round base, aluminum					•							
O3.	HF16.3.61	Angled base collar, fits 1/2" square balusters, 1-9/16" round base, aluminum					•							
<b>9/16" Square Baluster Accessories</b>														
A.	HF16.3.3	Level base shoe, fits 9/16" square balusters, 1-5/16" square base, aluminum					•		•		•			
A.	HF16.3.20	Level base shoe with set screw, fits 9/16" square balusters, 1-5/16" square base, aluminum					•			•	•			
E.	HF16.3.17	Angled base shoe with set screw, fits 9/16" square balusters, 1-5/16" base, aluminum					•			•	•			
C.	HF16.3.25	Level base shoe with set screw, fits 9/16" Tuscan square balusters, 1-1/4" square base, cast iron					•			•			•	
G.	HF16.3.28	Angled base shoe with set screw, fits 9/16" Tuscan square balusters, 1-1/4" base, cast iron					•				•			
D.	HF16.3.41	Level base collar, fits 9/16" square balusters, 2" square base, cast iron									•			
H.	HF16.3.42	Level base collar, fits 9/16" square balusters, 1-15/16" round base, cast iron									•			
P.	HF16.3.11	Level base collar, fits 9/16" square balusters, 1-3/4" round base, cast iron									•			
<b>5/8" Square Baluster Accessories</b>														
C.	HF16.3.38	Level base shoe with set screw, fits 5/8" square balusters, 1-1/4" square base, cast iron					•			•			•	
G.	HF16.3.39	Angled base shoe with set screw, fits 5/8" square balusters, 1-1/4" base, cast iron					•				•		•	
P.	HF16.3.15	Level base collar, fits 5/8" square balusters, 1-3/4" round base, cast iron					•			•				
<b>3/4" Square Baluster Accessories</b>														
A.	HF34.3.19	Level base shoe with set screw, fits 3/4" square balusters, 1-7/8" square base, aluminum					•	•		•				
E.	HF34.3.2	Level base shoe with set screw, fits 3/4" square balusters, 1-7/8" square base, aluminum					•	•		•				
P.	HF34.3.16	Level base collar, fits 3/4" square balusters, 2" round base, cast iron					•	•		•				
<b>9/16" Round Baluster Accessories</b>														
I.	HF16.3.13	Level base shoe, fits 9/16" round balusters, 1-5/16" square base, aluminum					•							
M.	HF16.3.16	Angled base shoe with set screw, fits 9/16" round balusters, 1-5/16" base, aluminum					•							
J.	HF16.3.26	Level base shoe with set screw, fits 9/16" round balusters, 1-1/4" square base, cast iron					•			•			•	
N.	HF16.3.27	Angled base shoe with set screw, fits 9/16" round balusters, 1-1/4" base, cast iron					•				•		•	
K.	HF16.3.40	Level base collar, fits 9/16" round balusters, 2" square base, cast iron									•			
O.	HF16.3.43	Level base collar, fits 9/16" round balusters, 1-15/16" round base, cast iron									•			
Q.	HF16.3.10	Level base collar, fits 9/16" round balusters, 1-9/16" round base, cast iron					•				•			
L.	HF17.11.22	Level base collar, fits 9/16" round stainless steel balusters, 1-1/2" round base, stainless steel												
<b>5/8" Round Baluster Accessories</b>														
J.	HF16.3.35	Level base shoe with set screw, fits 5/8" round balusters, 1-1/4" square base, cast iron					•	•		•			•	
N.	HF16.3.36	Angled base shoe with set screw, fits 5/8" round balusters, 1-1/4" base, cast iron					•	•		•			•	
I.	HF16.3.50	Level base shoe with set screw, fits 5/8" round balusters, 1-5/16" square base, aluminum					•			•				
M.	HF16.3.51	Angled base shoe with set screw, fits 5/8" round balusters, 1-5/16" base, aluminum					•				•			
Q.	HF16.3.12	Level base collar, fits 5/8" round balusters, 1-9/16" round base, cast iron					•	•		•				
<b>Adjustable Shoes/Colars have a flexible insert that allows them to be used with either square or round balusters ranging in size from 1/2" to 9/16". Epoxy must be used to permanently secure.</b>														
R.	HF16.3.44	Level base shoe, fits 1/2" - 9/16" square or round balusters, 1-5/16" square base, cast iron					•			•			•	
R.	HF16.3.46	Level base shoe, fits 1/2" - 9/16" square or round balusters, 1-1/2" square base, cast iron					•			•			•	
S.	HF16.3.45	Angled base shoe, fits 1/2" - 9/16" square or round balusters, 1-5/16" base, cast iron									•		•	
S.	HF16.3.47	Angled base shoe, fits 1/2" - 9/16" square or round balusters, 1-1/2" base, cast iron									•		•	
<b>Newel Mounting Kits</b>														
T.	HF16.2.3	Newel mounting kit with level base shoe, fits 1-3/16" square newels, 3-1/8" square base, cast iron					•	•		•	•		•	
T.	HF16.3.31	Newel mounting kit with level base shoe, fits 1" square newels, 3-1/8" square base, cast iron					•			•			•	
U.	HF16.3.14	Newel mounting kit with level base shoe, fits 1-3/16" round newels, 3-1/8" square base, cast iron					•	•		•			•	
U.	HF16.3.33	Newel mounting kit with level base shoe, fits 1" round newels, 3-1/8" square base, cast iron					•	•		•			•	
V.	HF17.2.3	Newel mounting kit with level base collar, fits 1-3/16" round stainless steel newels, 3-1/4" round base, stainless steel												
V2.	HF16.2.9	Newel mounting kit, fits 1-3/16" round newels, flange cover sold separately. Flange covers: STB, AG, Stainless, Brass												
<b>Handrail Brackets</b>														
W.	HF3002	Handrail bracket, 1-1/4" x 2-3/8" mounting plate, extends out 3" from wall, aluminum Also available in Brushed Chrome HFBC.3002, Polished Brass HFPB.3002					•	•	•	•	•		•	
X.	HF3003	Handrail bracket, 2-1/16" round mounting plate, extends out 3" from wall, aluminum Also available in Chrome HFCE.3003, Brushed Chrome HFBC.3003, Nickel HFNL.3003, Polished Brass HFPB.3003					•	•	•	•	•		•	



# ACCESSORY PROFILES

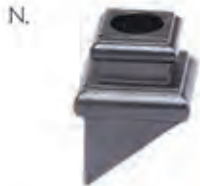

## Flange Covers

Use with HF16.2.9  
Newel Mounting Kit  
Fits 1-3/16" Round Newels  
Diameter: 4.13" Height: .7"

- SATIN BLACK HFSTB16.4.5
- ASH GREY HFAG16.4.5
- BRASS HF18.4.5
- STAINLESS STEEL HF17.4.5



Flange covers sold separately



EPC-101  
Epoxy Gun

EPC-410  
EPC-410-BLACK  
Epoxy



EPC-7  
Epoxy Paste



HFSTB-120Z CAN  
Satin Black Touch-up Paint



HFSTB-PEN  
Satin Black  
Touch-up Pen

HFORB-PEN  
Oil Rubbed Bronze  
Touch-up Pen



## Forged Panels

**House of Forgings  
is dedicated to  
providing superior  
products that meet the  
highest standards of  
architects,  
homebuilders  
and homeowners.**

We are pleased to provide a full line of prefabricated ornamental iron components. These elegant products allow for the look and feel of a fully custom fabricated iron stair or railing system. In addition to cost savings, installation time is greatly reduced compared to traditional fabrication.

STAIR & RAILING PRODUCTS BY





Rebecca panels paired with Monte Carlo balusters (shown)

# REBECCA



Rebecca HFRB.A1 (shown)

5/8" ROUND IRON



1/2" ROUND IRON

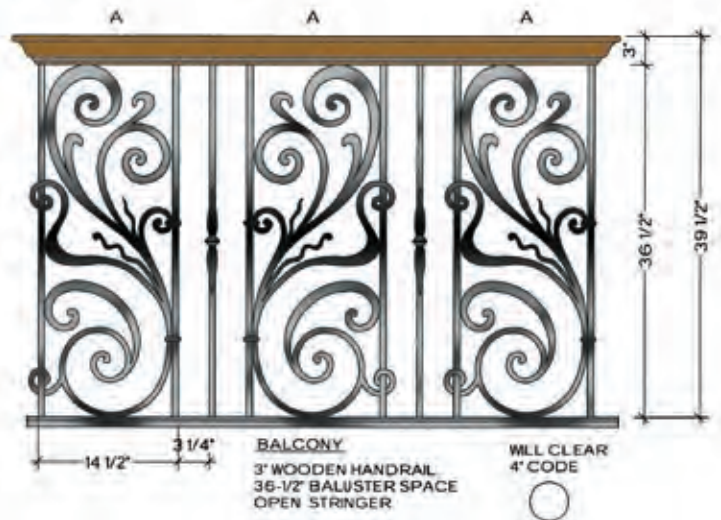
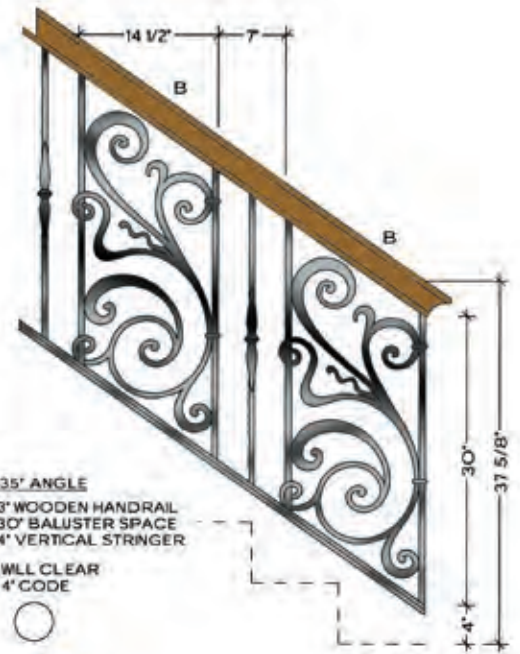

# REBECCA

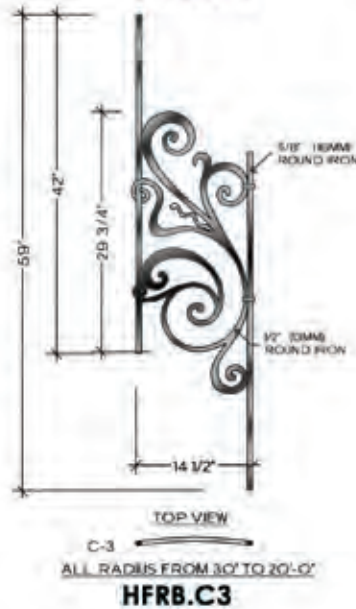
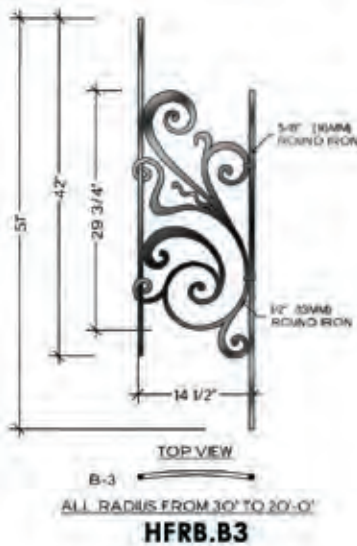
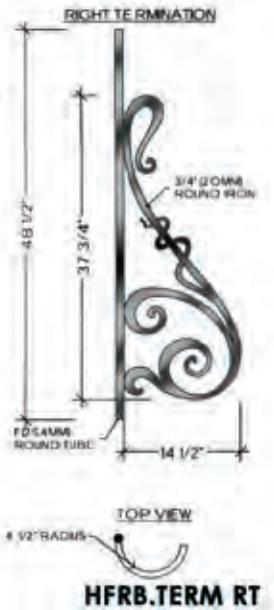
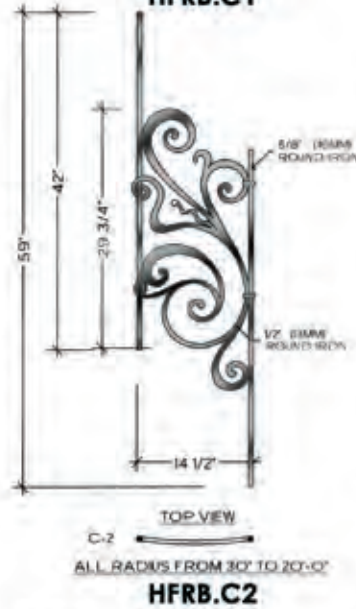
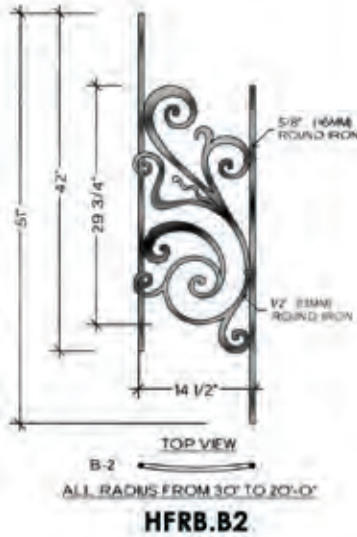
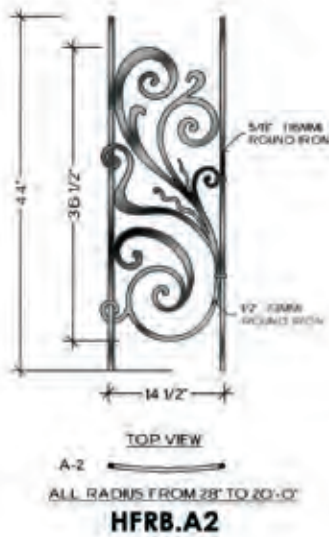
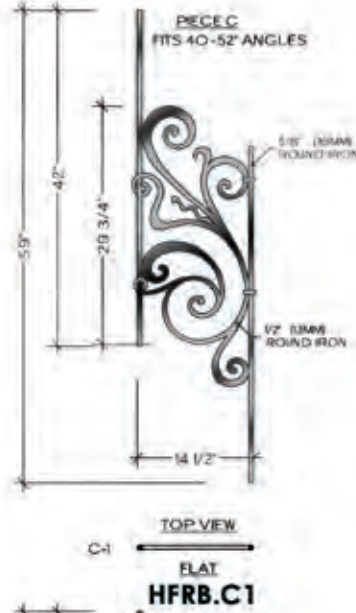
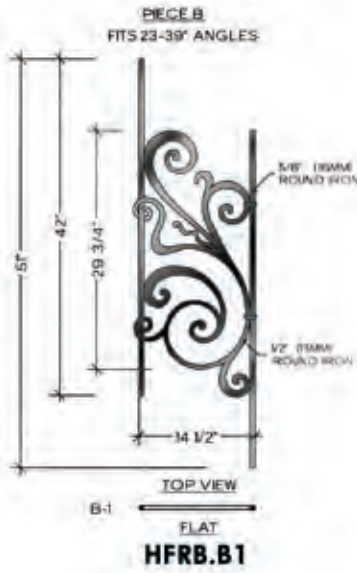
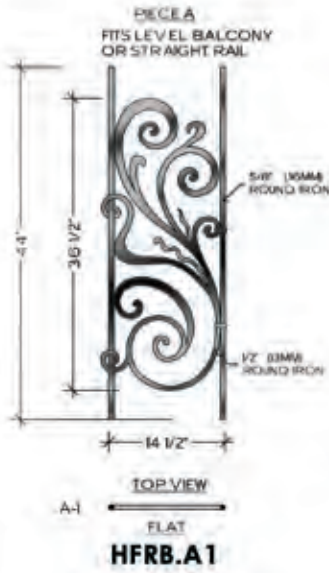

# TUSCANY



Tuscany HFTU.A1 (shown)

1/2" SQUARE  
IRON

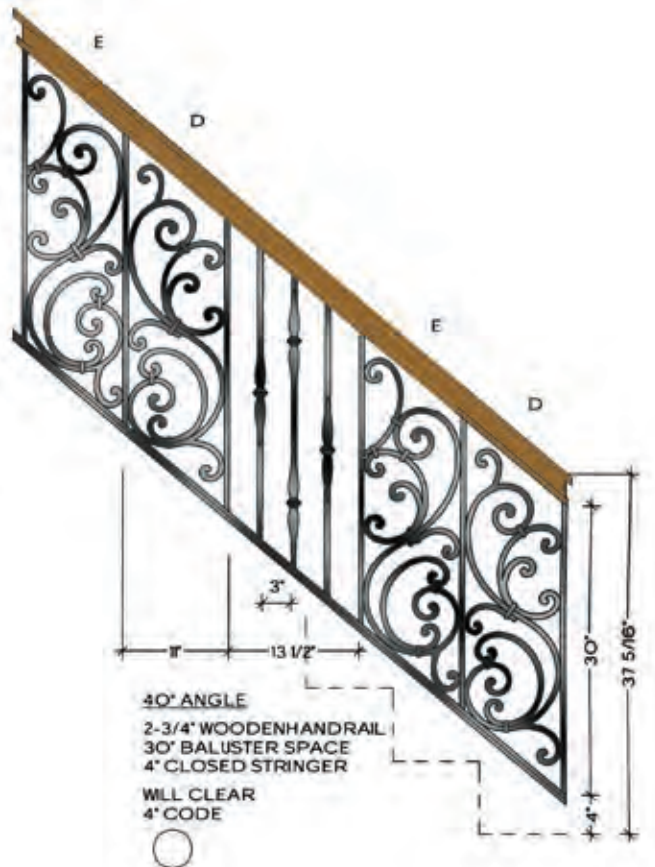

# TUSCANY

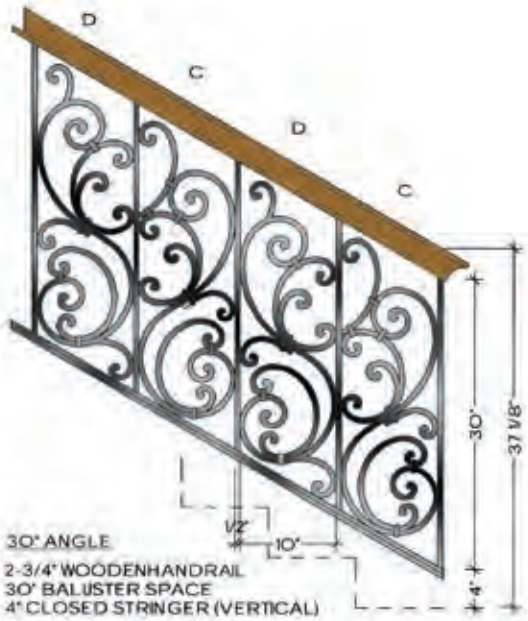

WILL CLEAR  
 4" CODE



40° ANGLE

3" WOODEN HANDRAIL  
 30" BALUSTER SPACE  
 4" CLOSED STRINGER (VERTICAL)  
 WILL CLEAR  
 4" CODE



RIGHT TERMINATION  
 LEFT SIDE VIEW

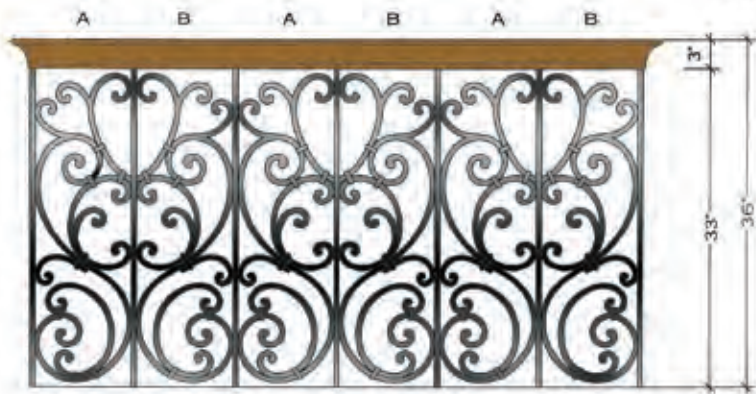

1/2" 10"

BALCONY  
 3" WOODEN HANDRAIL  
 33" BALUSTER SPACE

WILL CLEAR  
 4" CODE



1/2" 10" 1/2" 3" 14 1/2"

BALCONY  
 3" WOODEN HANDRAIL  
 33" BALUSTER SPACE

WILL CLEAR  
 4" CODE



# TUSCANY

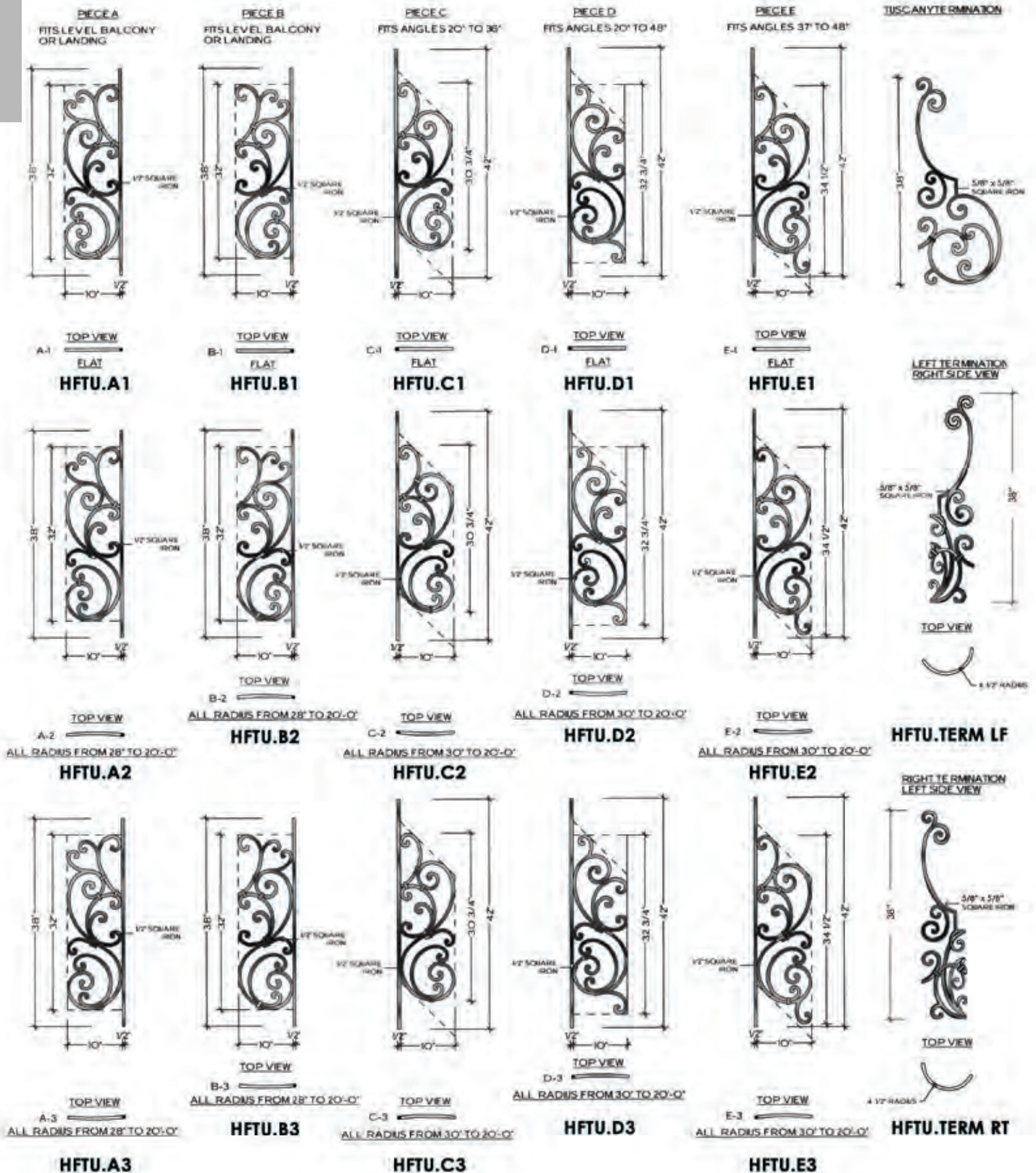





Tuscany panels paired with Gothic balusters (shown)

# SEVILLE



Seville HFSE.A1 (shown)

1/2" SQUARE IRON



45° ANGLE  
2-1/2" WOODEN HANDRAIL  
30" BALUSTER SPACE  
4" VERTICAL STRINGER

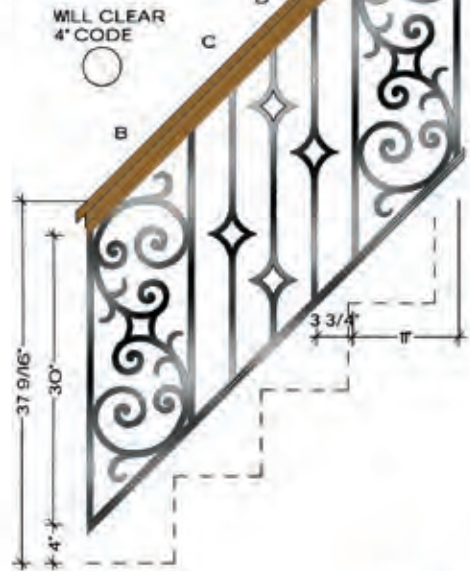

30° ANGLE  
3" WOODEN HANDRAIL  
30" BALUSTER SPACE  
4" VERTICAL STRINGER

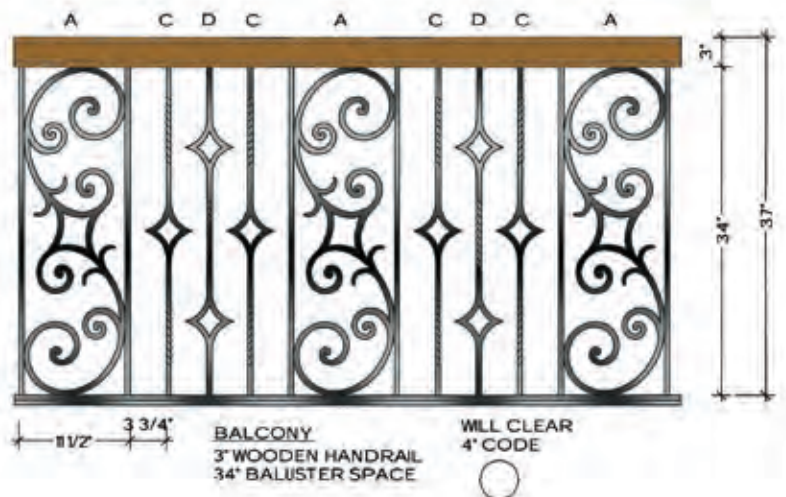

# SEVILLE

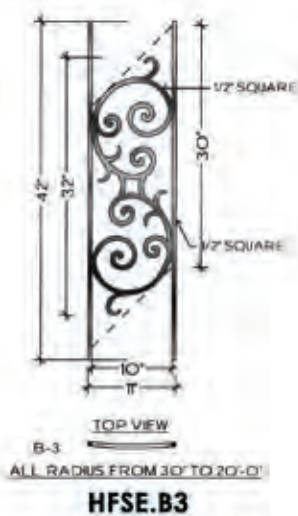
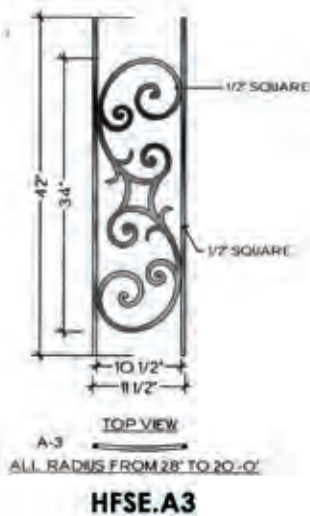
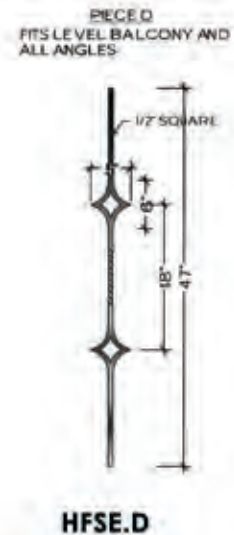
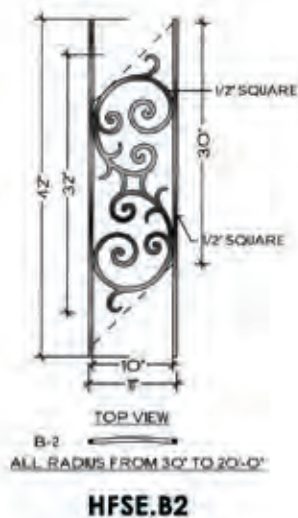
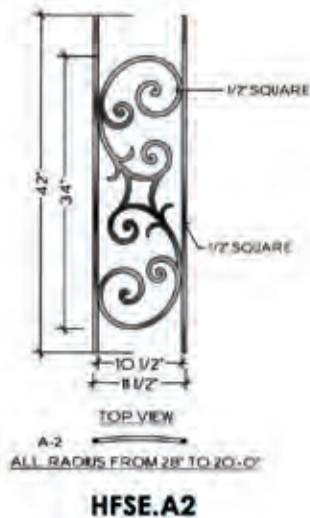
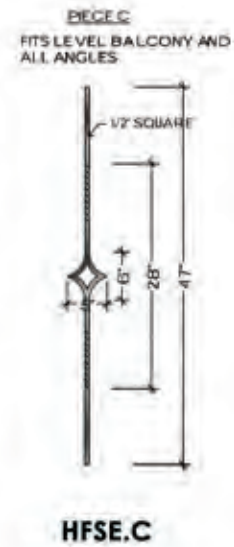
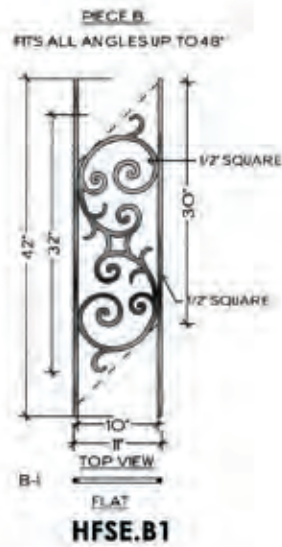
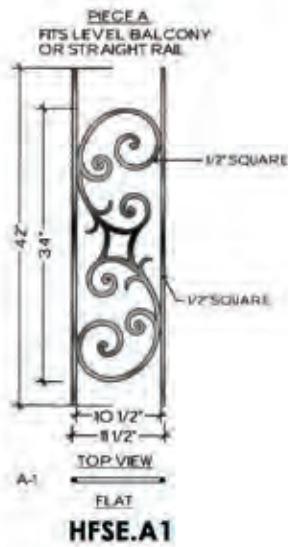

# MILANO



Milano HFMO.A1 (shown)

3/4" SQUARE  
TUBE



1/2" SQUARE  
IRON

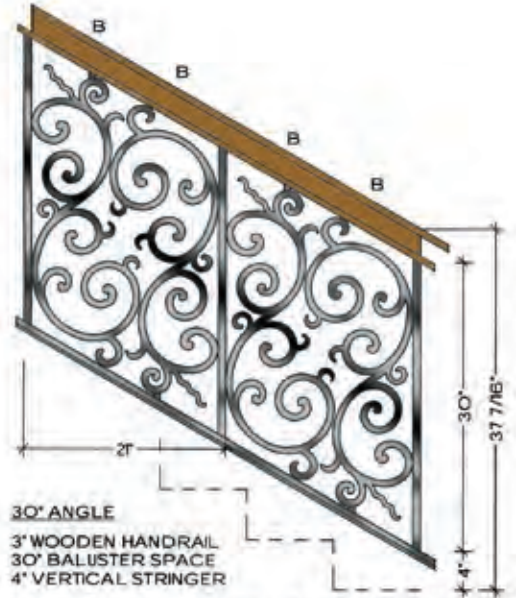

"NOTE: THE MILANO LAYOUT REQUIRES THE REMOVAL OF SOME ATTACHED VERTICALS AND REWELDING SCROLLS TO PREVIOUS VERTICAL"

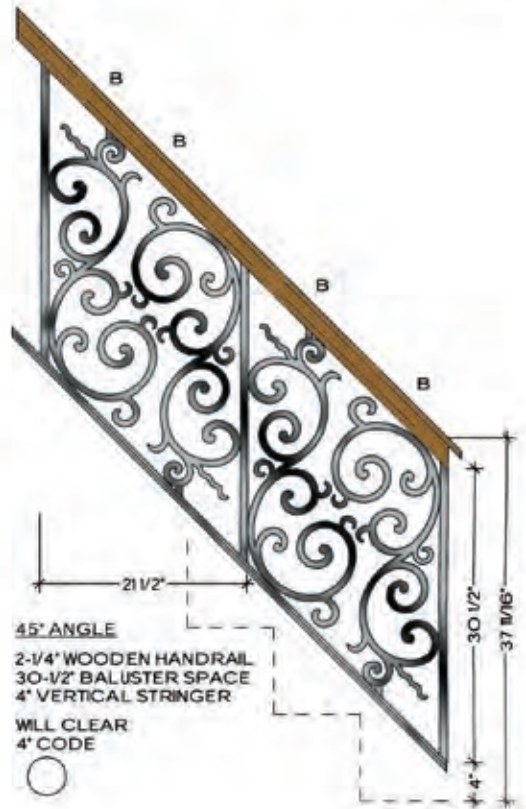

# MILANO

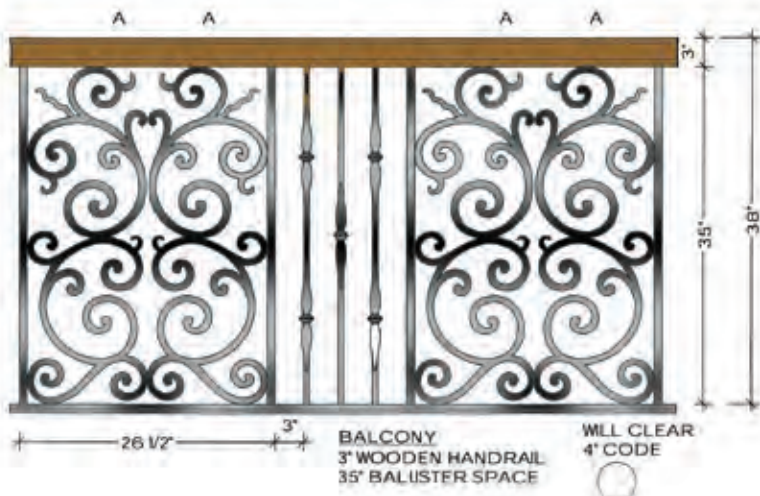
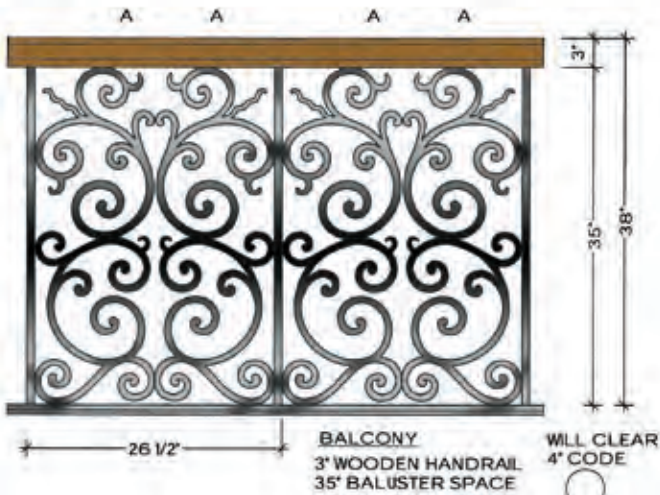
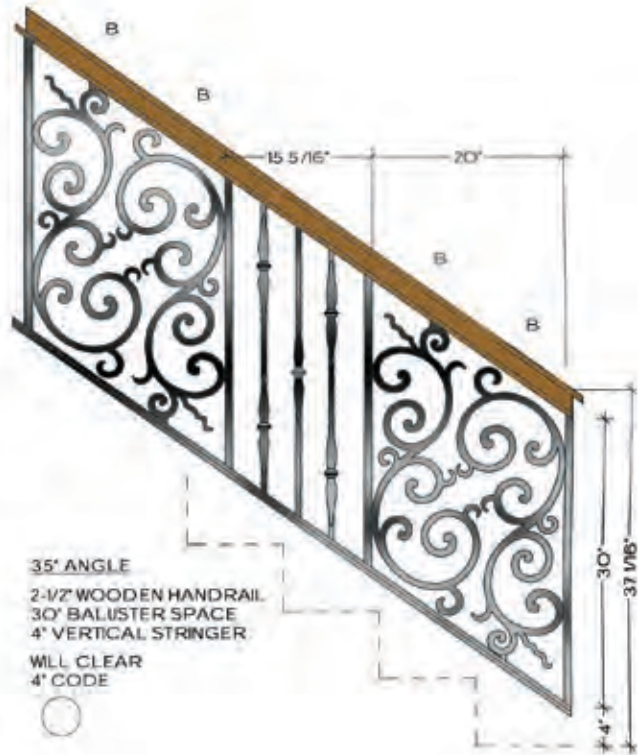

# MILANO

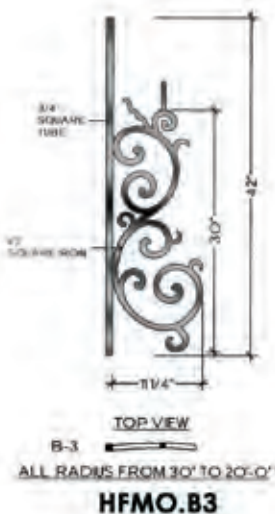
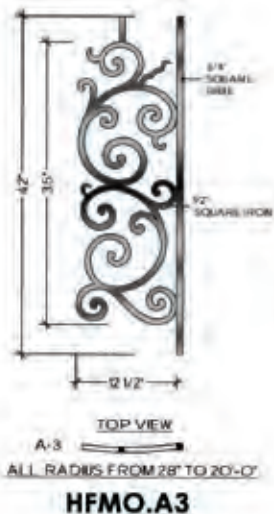
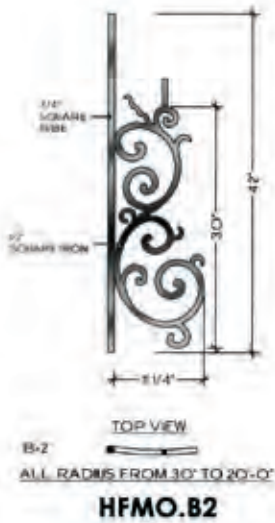
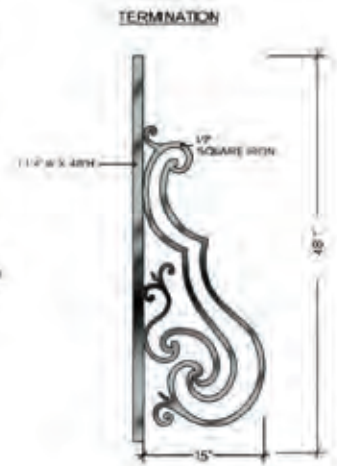
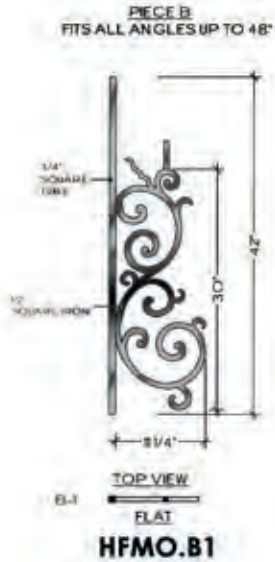



# BORDEAUX



Bordeaux HFBX.A1 (shown)

3/4" SQUARE  
TUBE



5/8" SQUARE  
IRON

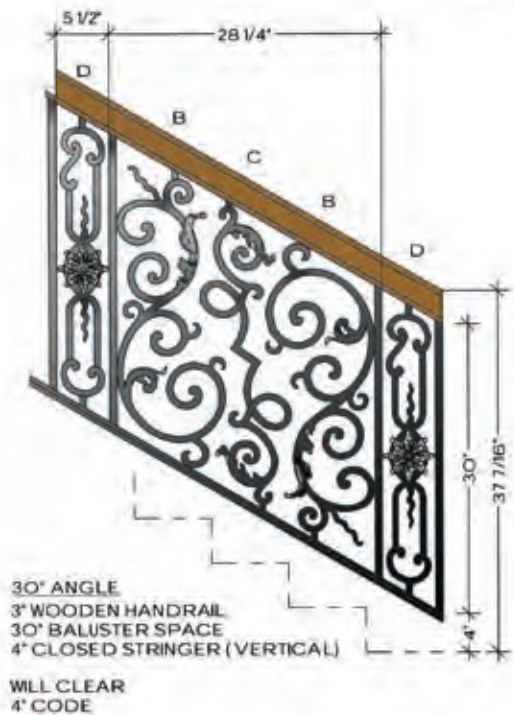



# BORDEAUX

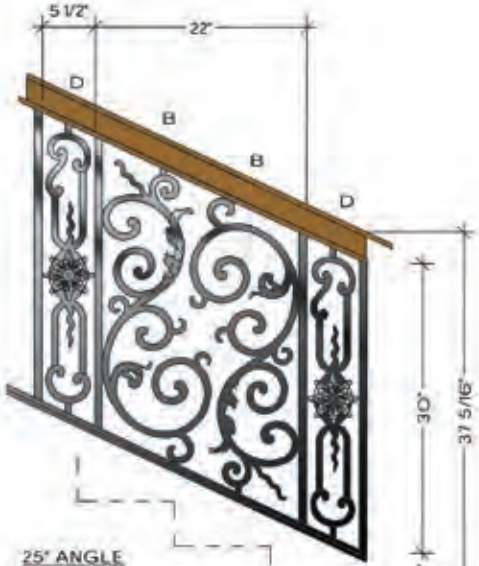

25° ANGLE  
 3" WOODEN HANDRAIL  
 30" BALUSTER SPACE  
 4" CLOSED STRINGER (VERTICAL)

WILL CLEAR  
 4" CODE

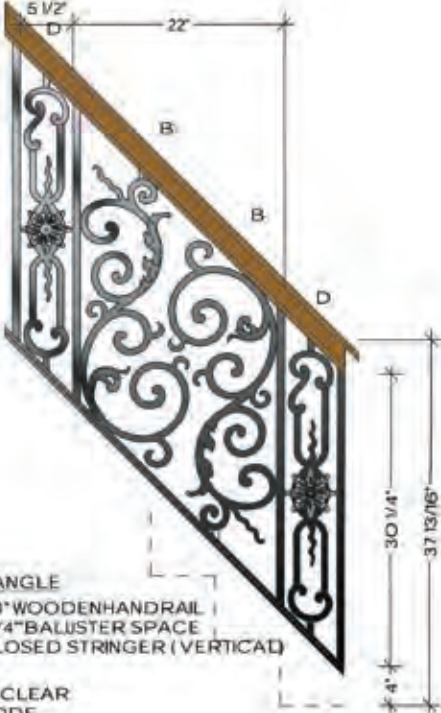

45° ANGLE  
 2-3/4" WOODEN HANDRAIL  
 30-1/4" BALUSTER SPACE  
 4" CLOSED STRINGER (VERTICAL)

WILL CLEAR  
 4" CODE

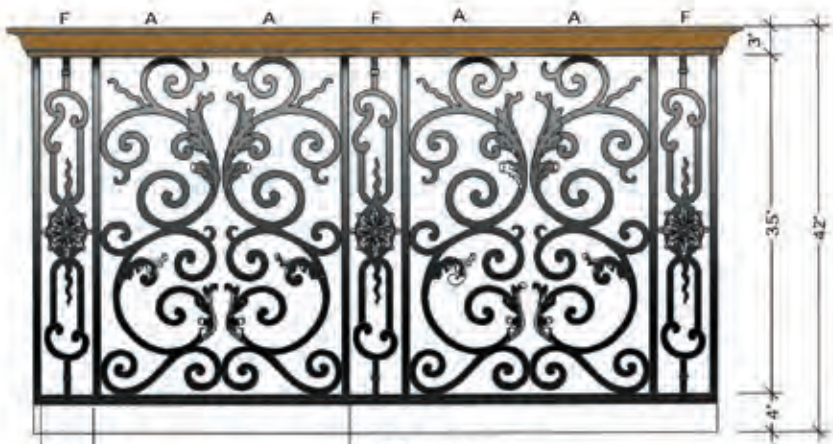

BALCONY  
 3" WOODEN HANDRAIL  
 35" BALUSTER SPACE  
 4" CLOSED STRINGER

WILL CLEAR  
 4" CODE



# BORDEAUX

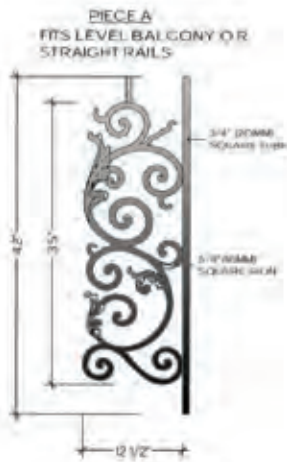

TOP VIEW  
A-1  
FLAT  
**HFBX.A1**

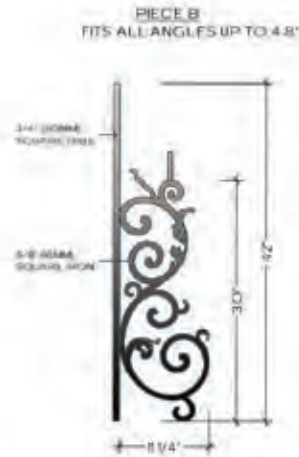

TOP VIEW  
B-1  
FLAT  
**HFBX.B1**



TOP VIEW  
B-1  
FLAT  
**HFBX.B1**

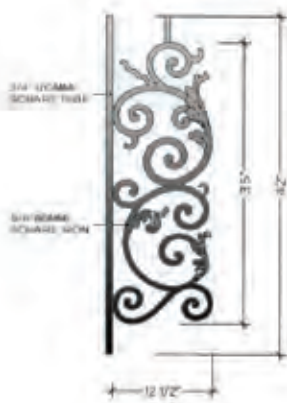

TOP VIEW  
A-2  
ALL RADIUS FROM 20" TO 200"  
**HFBX.A2**

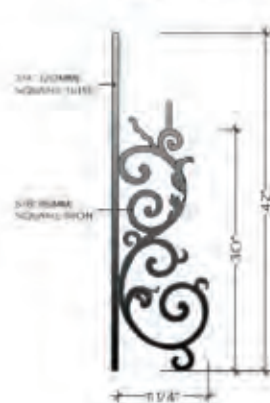

TOP VIEW  
B-2  
ALL RADIUS FROM 30" TO 200"  
**HFBX.B2**



TOP VIEW  
B-2  
ALL RADIUS FROM 30" TO 200"  
**HFBX.B2**



TOP VIEW  
A-3  
ALL RADIUS FROM 20" TO 200"  
**HFBX.A3**

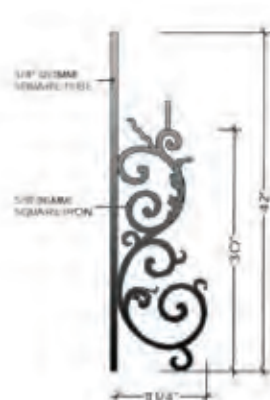

TOP VIEW  
B-3  
ALL RADIUS FROM 30" TO 200"  
**HFBX.B3**



TOP VIEW  
B-3  
ALL RADIUS FROM 30" TO 200"  
**HFBX.B3**

# BORDEAUX

**PIECE C**  
FITS ONLY INCLINE ANGLES BELOW 40°



**HFBX.C1**

**PIECE D**  
FITS ALL ANGLES



**HFBX.D**

**PIECE E**  
FITS ONLY ANGLES ABOVE 40°



**HFBX.E1**

**RIGHT TERMINATION**  
INSIDE VIEW

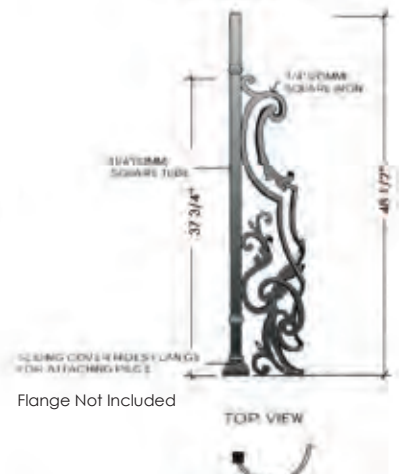

Flange Not Included

**HFBX.TERM RT**

**LEFT TERMINATION**  
INSIDE VIEW

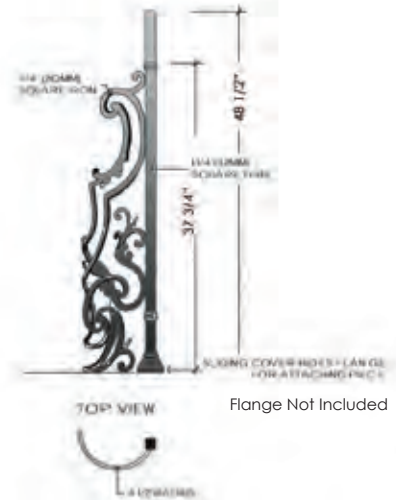

Flange Not Included

**HFBX.TERM LF**



**HFBX.C2**

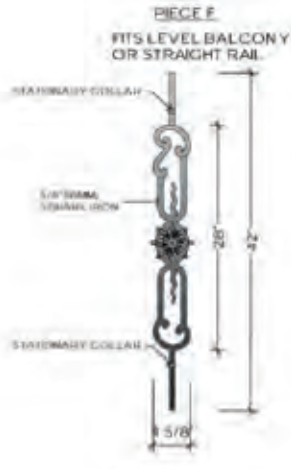

**HFBX.F**



**HFBX.E2**



**HFBX.C3**



**HFBX.E3**

# REGENCY



Regency HFREA1 (shown)

1" SQUARE  
TUBE



3/8" X 1"  
FLAT IRON

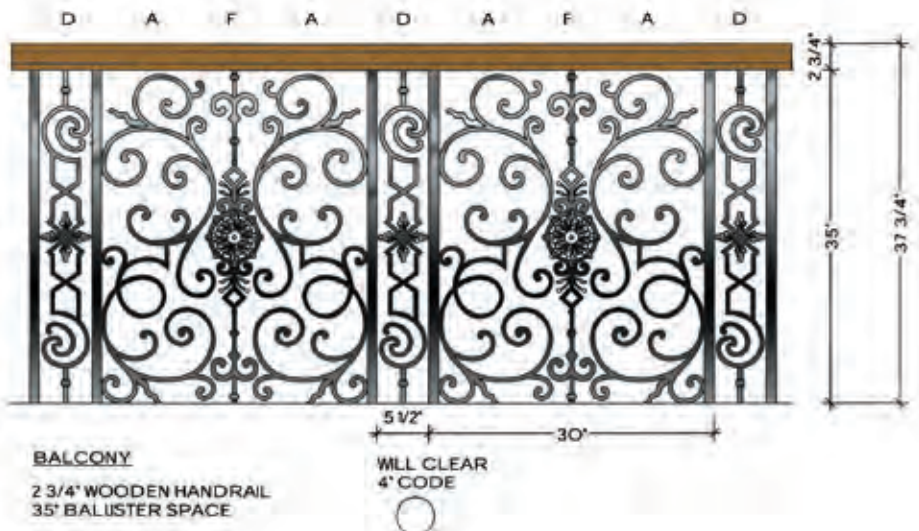
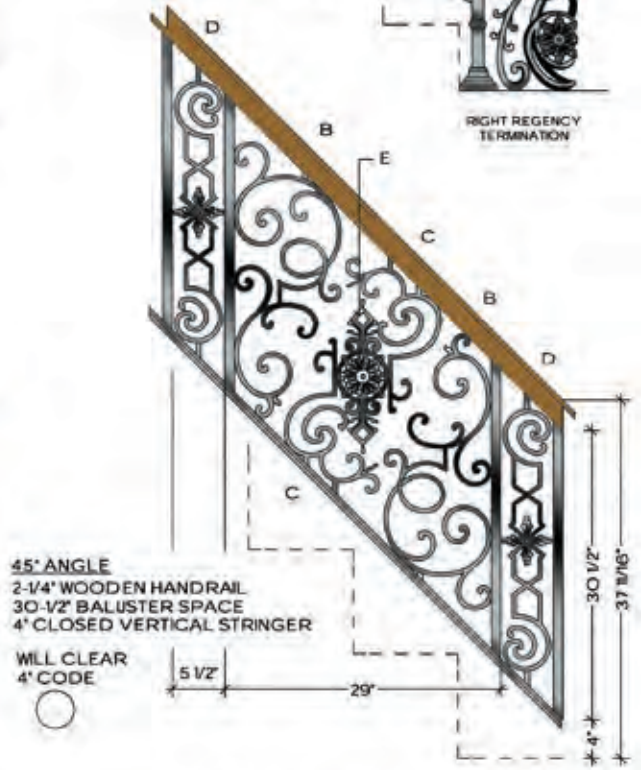
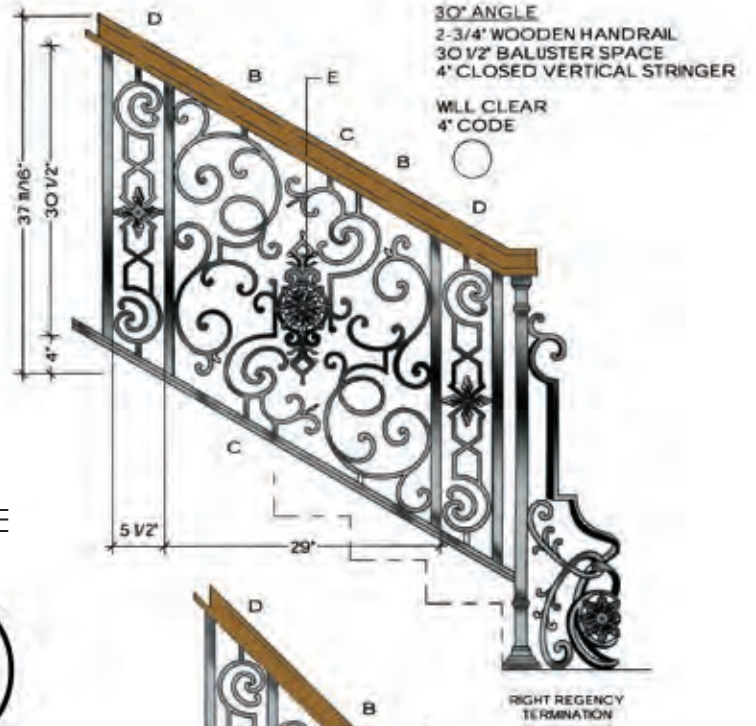

# REGENCY

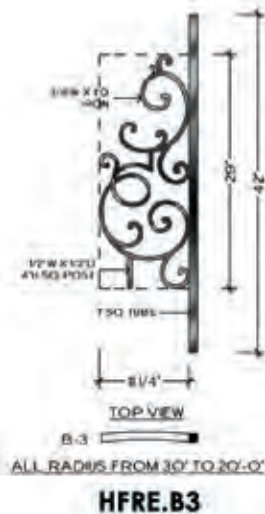
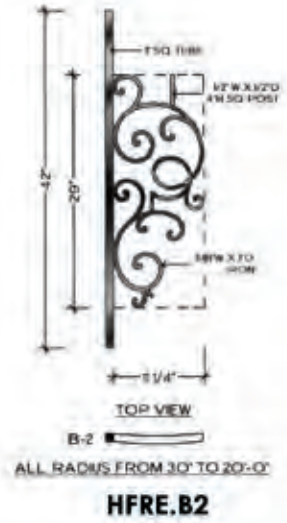
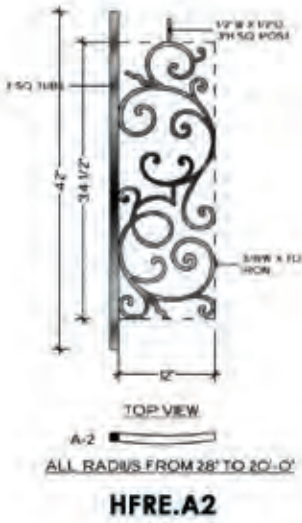
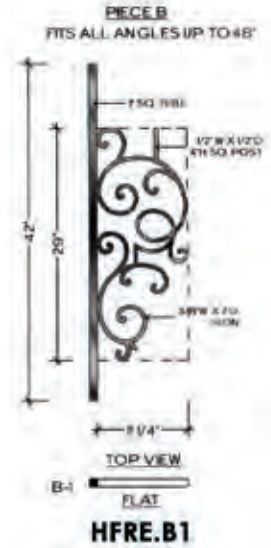
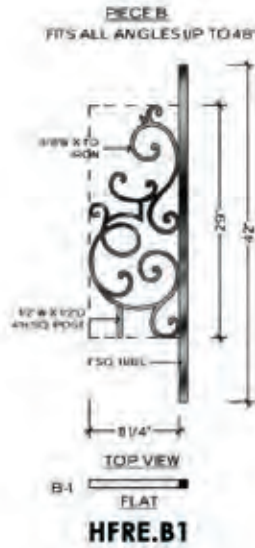
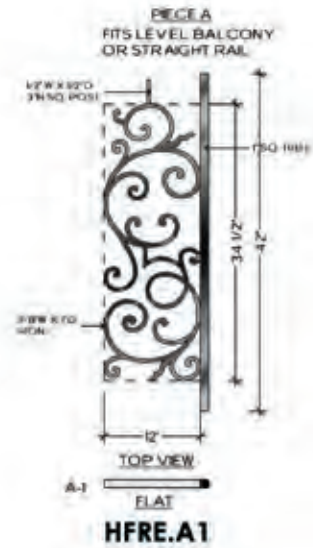

# REGENCY

**PIECE C**  
FITS ALL ANGLES UP TO 48°



TOP VIEW  
FLAT

**HFRE.C1**

**PIECE C**  
FITS ALL ANGLES UP TO 48°

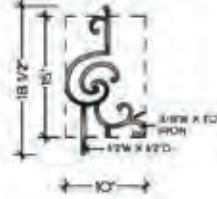

TOP VIEW  
FLAT

**HFRE.C1**

**LEFT SIDE TERMINATION**  
RIGHT SIDE VIEW

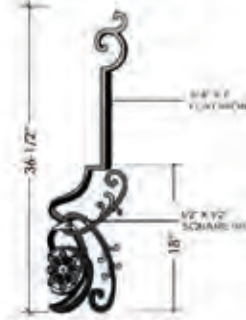

**HFRE.TERM LF**

**RIGHT SIDE TERMINATION**  
LEFT SIDE VIEW

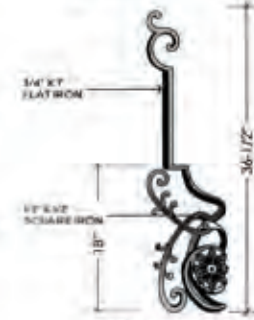

**HFRE.TERM RT**

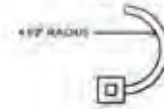

C-2  
TOP VIEW

ALL RADIUS FROM 30° TO 20°-0'

**HFRE.C2**

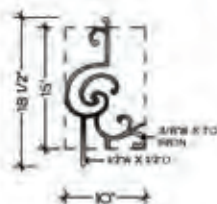

C-2  
TOP VIEW

ALL RADIUS FROM 30° TO 20°-0'

**HFRE.C2**



C-3  
TOP VIEW

ALL RADIUS FROM 30° TO 20°-0'

**HFRE.C3**

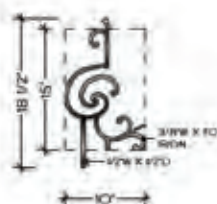

C-3  
TOP VIEW

ALL RADIUS FROM 30° TO 20°-0'

**HFRE.C3**

**TERMINATION**



**PIECE D**  
FITS ALL ANGLES &  
LEVEL BALCONY



TOP VIEW  
FLAT **HFRE.D**

**PIECE E**  
FITS ALL ANGLES



**HFRE.E**

**PIECE F**  
FITS LEVEL BALCONY  
OR STRAIGHT RAIL



TOP VIEW  
FLAT **HFRE.F**



U.S. Pat.  
No. 5,820,111  
No. 6,059,269

Regency panels (shown)

Regency<sup>®</sup>

## Wood Products

**At House of Forgings we provide much more than just forged iron products, we boast an extensive line of wood components as well.**

From handrails to treads, we carry virtually all components necessary to create the staircase or balcony you have envisioned. All products are stocked in the most popular domestic species, ready for immediate shipping.

Components are packaged and shipped with the utmost integrity ensuring that your order will arrive on time and undamaged.

STAIR & RAILING PRODUCTS BY

 **HOUSE OF FORGINGS**





Magnolia newels (RO-4040) paired with Aalto balusters in Satin Black (HFSTB 16.6.3) (shown)



# FORESTKRAFT™

WOOD STAIR & RAILING PRODUCTS



## Box Newels

Non removable caps - Stocked in Red Oak and White Oak  
Call for additional species availability.



Modern  
Box Newel  
Small  
**4400**  
HT. 56"  
W = 3-1/4"  
SOLID



Modern  
Box Newel  
Large  
**5400**  
HT. 56"  
W = 5-1/2"  
SOLID



Shown with  
optional base  
4-1/2" x 21-3/4"  
(sold separately)  
**BASE-4000**



Shown with  
optional base  
6-1/2" x 21-3/4"  
(sold separately)  
**BASE-5000**

## Routed Newels

Non removable caps - Stocked in Red Oak and White Oak  
Call for additional species availability.



Modern  
Routed Newel  
**4900**  
HT. 56"  
W = 3-1/4"  
SOLID



Modern  
Routed Newel  
**5900**  
HT. 56"  
W = 5-1/2"  
SOLID



Shown with  
optional base  
4-1/2" x 21-3/4"  
(sold separately)  
**BASE-4000**



Shown with  
optional base  
6-1/2" x 21-3/4"  
(sold separately)  
**BASE-5000**

## Blank Newel Caps

Available for: 3-1/4" and 5-1/2" blank newels  
Stocked in Red Oak and White Oak - Sold separately



<b>3-1/4"</b> Square Newels	<b>SQUARE-CAP-4000</b> HT. 1-3/4" W= 3-1/4"	<b>PYRAMID-CAP-4000</b> HT. 1-9/16" W= 3-1/4"	<b>STACKED-CAP-4000</b> HT. 2-1/4" W= 3-1/4"	<b>COVE-CAP-4000</b> HT. 2-1/2" W= 4-5/8"
<b>5-1/2"</b> Square Newels	<b>SQUARE-CAP-5000</b> HT. 2" W= 5-1/2"	<b>PYRAMID-CAP-5000</b> HT. 1-5/8" W= 5-1/2"	<b>STACKED-CAP-5000</b> HT. 2-3/4" W= 5-1/2"	<b>COVE-CAP-5000</b> HT. 2-7/8" W= 6-7/8"

## Newel Bases

Stocked in Red Oak and White Oak



## Blank Newels

Stocked in Red Oak and White Oak



## Blank Newel Options: Caps / Bases

3-1/4" and 5-1/2" blank newels, shown with optional bases and caps - sold separately  
Additional configuration options available.



Call for additional species availability.

# BLANKS



**4007**  
HT. 54"  
W = 3-1/4"



Prefinished white  
**4913-41**  
HT. 41"  
W = 1-1/4"

\* SPECIAL ORDER IN RED OAK.

**We stock additional wood parts in our  
Conover, North Carolina Distribution Center!**

View or download  
The North Carolina In-Stock Product Catalog  
[houseofforgings.net/north-carolina-warehouse](http://houseofforgings.net/north-carolina-warehouse)

# CLASSIC



**5140**  
HT. 48"  
W = 3-1/4"



**4140-SP**  
HT. 48"  
W = 3"  
STABILIZER  
NEWEL



**5160**  
HT. 54"  
W = 3-1/4"



**5170**  
HT. 54"  
W = 3-1/4"

# CLASSIC



Prefinished white  
**4121-41**  
HT. 41"  
W = 1-1/4"

\* SPECIAL ORDER



Prefinished white  
**4120-41**  
HT. 41"  
W = 1-3/4"



Prefinished white  
**4220-41**  
HT. 41"  
W = 2-1/4"

\* SPECIAL ORDER



Prefinished white  
**5067-36**  
HT. 36"  
W = 1-1/4"

**5067-39**  
HT. 39"  
W = 1-1/4"

**5067-41**  
HT. 41"  
W = 1-1/4"

# MAGNOLIA



**4010-48**

Ht. 48"  
W = 3"

**4010-3.5**

Ht. 48"  
W = 3-1/2"



**4010-SP**

Ht. 48"  
W = 3"  
STABILIZER  
NEWEL



**4040**

Ht. 48"  
W = 3"

**4042**

Ht. 54"  
W = 3"

**4042-3.5**

Ht. 54"  
W = 3-1/2"



**4045**

Ht. 54"  
W = 3"

**4045-3.5**

Ht. 54"  
W = 3-1/2"



Prefinished white

**5015-36**

Ht. 36"  
W = 1-1/4"

**5015-39**

Ht. 39"  
W = 1-1/4"

**5015-41**

Ht. 41"  
W = 1-1/4"

**5015-43**

Ht. 43"  
W = 1-1/4"

# CONCORD



**4315**

Ht. 48"  
W = 3"



**4301**

Ht. 54"  
W = 3"

**4501**

Ht. 54"  
W = 3-1/4"



**4305**

Ht. 54"  
W = 3"

**4505**

Ht. 54"  
W = 3-1/4"



**4270-SP**

Ht. 54"  
W = 3-1/4"  
STABILIZER  
NEWEL

# REMINGTON



Prefinished white

**4605-41**

Ht. 41"  
W = 1-3/4"

\*SPECIAL ORDER

## Wood Products

Our wood products are stocked in the most popular domestic species.



Red Oak  
(RO)

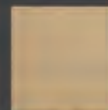

White Oak  
(WO)

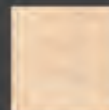

Maple  
(ME)

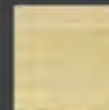

Poplar  
(PR)



Prefinished White  
(PG)

## Domestic and Exotic Wood Species

All wood products in non-stock species are available by special order.

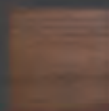

Walnut  
(WT)

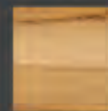

Hickory/Pecan  
(HY)

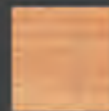

Clear Alder  
(AR)

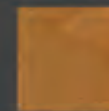

American Cherry  
(CY)



Mahogany  
(MY)



BOX NEWELS



Contemporary Box Newel  
**4191**  
HT. 56"  
W = 3-1/4"  
SOLID



Contemporary Stabilizer Newel  
**4191-SP**  
HT. 43"  
W = 3"  
SOLID



Stabilizer newels are pre drilled 1/2" x 2-1/8" (7/16" x 3" dowel included)



Plain Box Newel  
**961-56**  
HT. 56"  
W = 4-1/2"  
SOLID



Recessed Panel Box Newel  
**4291**  
HT. 56"  
W = 6"  
HOLLOW



All box newels come with both square and pyramid tops

BOX NEWELS



Adjustable Box Newel  
**4592**  
HT. 56"  
W = 5"  
SOLID



Plain Newel  
**4592-PLAIN**  
HT. 56"  
W = 3-1/2"  
SOLID



Stabilizer Newel  
**4592-SP**  
HT. 43"  
W = 3"  
SOLID



Stabilizer newels are pre drilled 1/2" x 2-1/8" (7/16" x 3" dowel included)



Raised Panel Box Newel  
**4791**  
HT. 56"  
W = 6-1/4"  
HOLLOW



Fluted Box Newel  
**4891**  
HT. 56"  
W = 6-1/4"  
HOLLOW



Recessed Panel Box Newel  
**4991**  
HT. 56"  
W = 6-1/4"  
HOLLOW

All box newels stocked in Red Oak (RO) and White Oak (WO) - Call for additional species availability.



RO-4691 Box Newel and 4923-41 Balusters (shown)

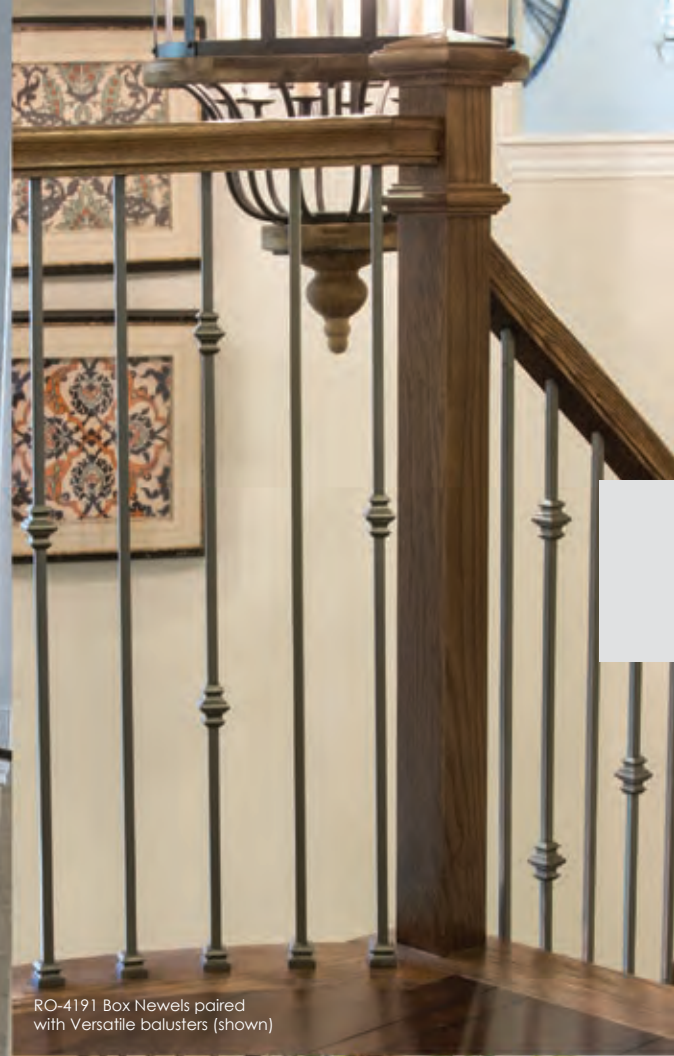

RO-4191 Box Newels paired with Versatile balusters (shown)



RO-4291 Box Newels paired with Versatile balusters (shown)

# HANDRAIL & FITTINGS



**6040**



**6040**  
Round Wall Rail  
Diameter: 1-5/8"

## RETURNED END



 7009  
 7209

**6010**





**6010**  
Colonial Hand Rail  
HT. 2-3/8"  
W. 2-1/2"

**6010** Straight Rail  
**6010-B** Bending Rail  
bending rail includes moulding



## OPENING CAP



 7019  
 7219

**6210**





**6210**  
Traditional Hand Rail  
HT. 2-3/8"  
W. 2-5/8"

**6210** Straight Rail  
**6210-B** Bending Rail  
bending rail includes moulding



## TANDEM CAP



 7020  
 7220

**6084**



**6084**  
Modern Hand Rail  
HT. 1-5/8"  
W. 2-5/8"

**6084** Straight Rail  
**6084-B** Bending Rail  
available in Poplar

## OVER EASING



 7013  
 7213  
 7413

**6002**





**6002**  
Modern Hand Rail  
HT. 1-5/8"  
W. 2-3/4"

**6002** Straight Rail  
**6002-B** Bending Rail  
no fittings available

## UP EASING 90 DEGREE



 7012  7014  
 7212  7214  
 7412

**6060**

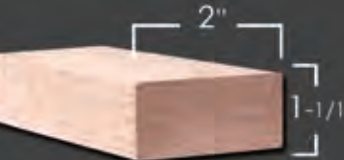



**6060**  
Modern Hand Rail  
HT. 1-1/16"  
W. 2"

**6060** Straight Rail  
no fittings available



## START EASING WITH CAP



 7010  
 7210



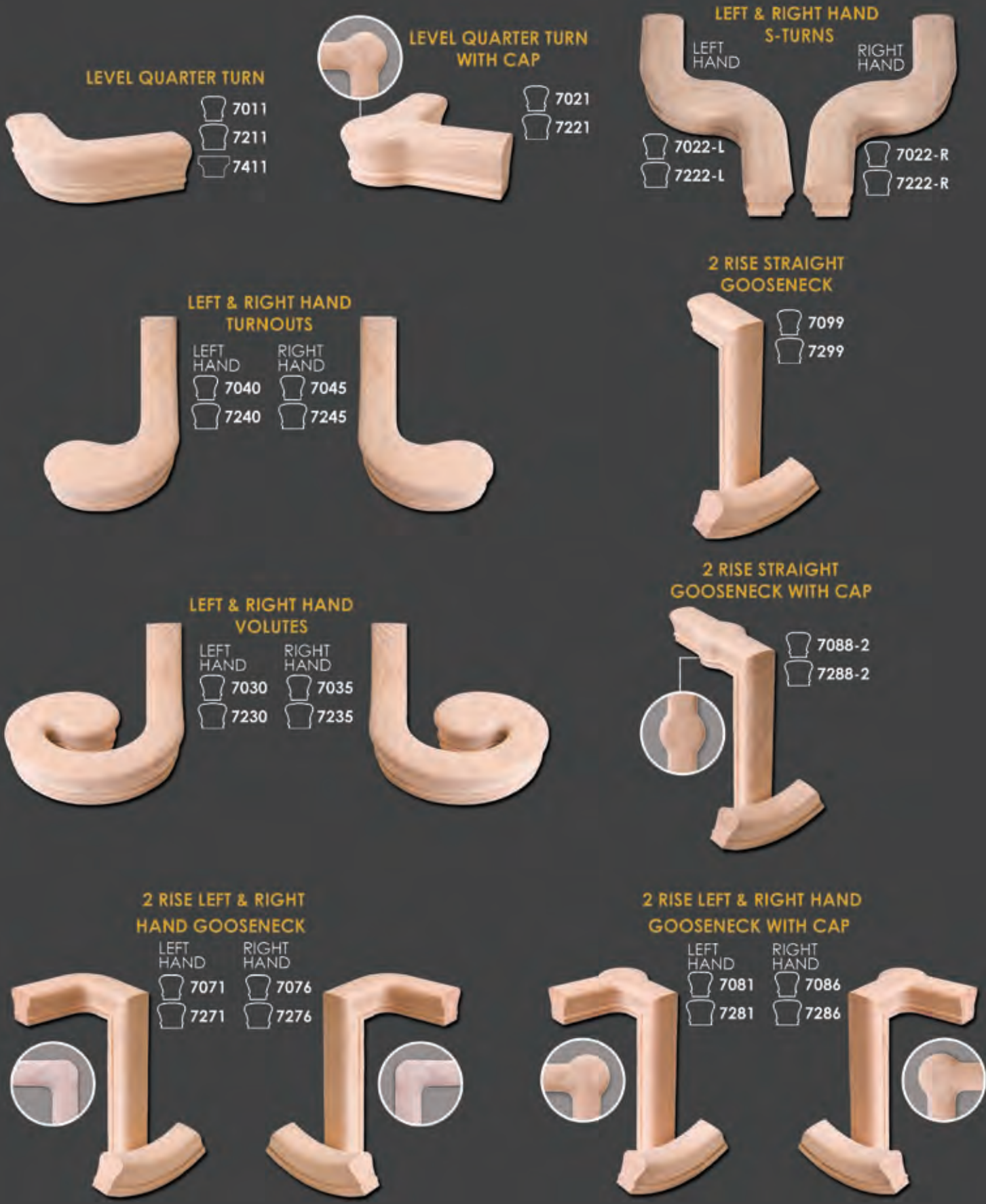

All handrail and fittings stocked in Red Oak (RO) - Call for additional species availability.

# TREADS / STEPS / LUMBER / PLY

## TREADS

### RO-8070

Red Oak Bull Nose Tread  
1-1/16" x 11-1/2" x 42, 48, 54,  
60, 72, 84, 96"



## CLASSIC TREADS

### RO-8070-13 x

Red Oak Tread  
1-1/16" x 13" x 48, 54, 60, 72, 84, 96"

### RO-8070-18 x

Red Oak Tread  
1-1/16" x 18" x 48, 54, 60, 72, 84"

### RO-8070-20 x 60

Red Oak Tread  
1-1/16" x 20" x 60"

### RO-8070-20 x 72

Red Oak Tread  
1-1/16" x 20" x 72"

### RO-8070-24 x

Red Oak Tread  
1-1/16" x 24" x 60", 72", 84", 96", 120"

### RO-8070-48 x 48

Red Oak Tread  
1-1/16" x 48" x 48"

### RO-8070-60 x 60

Red Oak Tread  
1-1/16" x 60" x 60"

### RO-8070-48-MR

1-1/16" x 11-1/2" x 48"

### RO-8070-54-MR

1-1/16" x 11-1/2" x 54"

### RO-8070-60-MR

1-1/16" x 11-1/2" x 60"

Mitered Return (MR) (Reversible)  
Overall length includes mitered return



## BULL NOSED LANDING TREAD

### 8090-6

RED OAK

### 8090-6B

RED OAK BENDING (26 pieces)



## TONGUE & GROOVED BULL NOSED LANDING TREAD

### 8090-6-G

RED OAK (grooved)



## TONGUE & GROOVED LUMBER

### 8095-8-T&G

RED OAK (tongue & grooved)

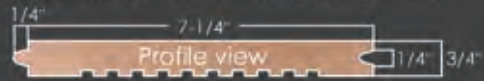

### 8095-12-T&G

RED OAK (tongue & grooved)

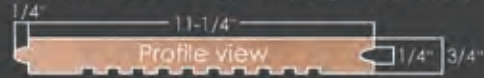

## 1" BULL NOSING

### 8080

RED OAK

### 8080-B

RED OAK BENDING  
(5 pieces)

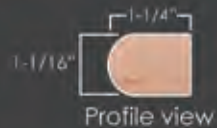

## REMODEL TREAD WITH RISER KIT

### TREAD

Red Oak Bull Nose Tread with Cove  
1-1/16" x 10-1/2" x 42, 54, 60"

### RISER

Red Oak Riser  
5/8" x 7-1/2" x 42, 54, 60"

### RETRO-42

### RETRO-54

### RETRO-60



## REMODEL RETURN TREAD WITH RISER KIT

### TREAD

Red Oak Bull Nose Tread with Cove  
1-1/16" x 10-1/2" x 48, 54, 60"

### RISER

Red Oak Riser  
5/8" x 7-1/2" x 48, 54, 60"

### RETRO-48MR

### RETRO-54MR

### RETRO-60MR



Reversible riser material for stain or paint.



No mitered return



Mitered return on  
left and right



Mitered return on right



Mitered return on left

# MODERN REMODEL TREAD & RISER KITS

- Get the look of thick block style treads at a fraction of the price!
- Replace old carpeted stairs
- Can be used on new construction

## REMODEL TREAD WITH RISER KIT

**TREAD** 2-1/8" Red Oak Tread w/roundover  
11/16" x 10-1/2" x 42, 54, 60"

**RISER** Red Oak Riser  
5/8" x 7-1/2" x 42, 54, 60"



Reversible riser material for stain or paint.



**MODERN-RETRO-42**  
**MODERN-RETRO-54**  
**MODERN-RETRO-60**



**2-1/8" THICK  
RED OAK**

## REMODEL RETURN TREAD WITH RISER KIT

**TREAD** 2-1/8" Red Oak Tread w/roundover  
Mitered return on both ends  
11/16" x 10-1/2" x 48, 54, 60"

**RISER** Red Oak Riser  
5/8" x 7-1/2" x 48, 54, 60"



Mitered return on left and right

Mitered return on right

Mitered return on left

2-1/8"

**MODERN-RETRO-48MR**  
**MODERN-RETRO-54MR**  
**MODERN-RETRO-60MR**



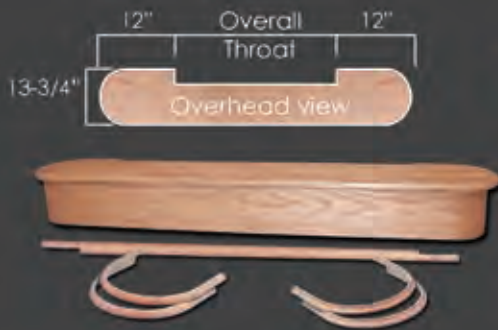

### DOUBLE END STARTING STEP

Diameter: 13-3/4"  
**8015-48** (48" throat) (72" overall)  
**8015-54** (54" throat) (78" overall)  
**8015-60** (60" throat) (84" overall)  
 Red Oak[RO]

Comes with:  
 1" Thick Tread,  
 6-3/4" Tall Riser  
 Cove & Quarter Round Moulding

### STARTER STEP VENEER

Width: 8"  
 Length: 120"  
**RO-VENEER** (Red Oak)

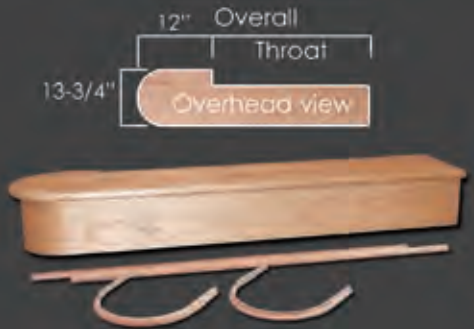
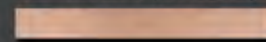

### SINGLE END STARTING STEP

Diameter: 13-3/4"  
**8010-48** (48" throat) (60" overall)  
**8010-60** (60" throat) (72" overall)  
**8010-72** (72" throat) (84" overall)  
 Red Oak[RO]

Comes with:  
 1" Thick Tread,  
 6-3/4" Tall Riser  
 Cove & Quarter Round Moulding

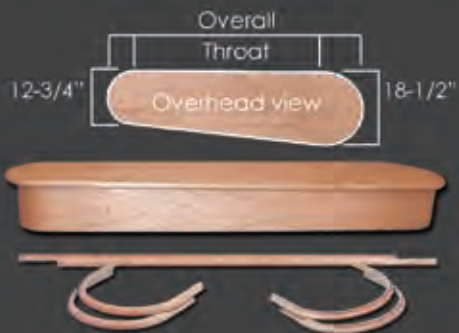

### SPECIAL WEDGE SHAPED DOUBLE END STARTING STEP

Diameter: 12-3/4" (small end)  
 Diameter: 18-1/2" (large end)  
**RO-8915-48** (48" throat) (73-1/2" overall)  
**RO-8915-54** (54" throat) (79-1/2" overall)  
 [Reversible]  
 Red Oak[RO]

Comes with:  
 1" Thick Tread,  
 6-3/4" Tall Riser  
 Cove & Quarter Round Moulding



### FALSE END STARTING STEP

Diameter: 13-3/4"      Diameter: 17-1/2"  
 Length: 17-5/8" overall      Length: 21-3/4" overall  
**8011**      **8012**  
 Red Oak[RO]

Comes with:  
 1" Thick Tread,  
 6-3/4" Tall Riser  
 Cove & Quarter Round Moulding

### PLYWOOD

<b>PLY-1/4-MDF</b>	MDF 1/4" x 4' x 8'	<b>Half Sheet</b> 1/4" x 2' x 8'
<b>PLY-3/4-MDF</b>	MDF 3/4" x 4' x 8'	
<b>PLY-1/8-RO</b>	Red Oak 1/8" x 4' x 8'	<b>Half Sheet</b> 1/4" x 2' x 8'
<b>PLY-1/4-RO</b>	Red Oak 1/4" x 4' x 8'	<b>Half Sheet</b> 1/4" x 2' x 8'
<b>PLY-1/2-RO</b>	Red Oak 1/2" x 4' x 8'	
<b>PLY-3/4-RO</b>	Red Oak 3/4" x 4' x 8'	
<b>PLY-1/8-Birch</b>	Birch 1/8" x 4' x 8'	
<b>PLY-1/4-Birch</b>	Birch 1/4" x 4' x 8'	<b>Half Sheet</b> 1/4" x 2' x 8'
<b>PLY-1/2-Birch</b>	Birch 1/2" x 4' x 8'	
<b>PLY-3/4-Birch</b>	Birch 3/4" x 4' x 8'	
<b>PLY-3/8-Bending</b>	Red Oak 3/8" x 4' x 8' (bending board)	

### LUMBER

<b>RO-06</b>	Red Oak 3/4" x 5-1/2" S4S Lumber
<b>RO-08</b>	Red Oak 3/4" x 7-1/4" S4S Lumber
<b>RO-08-B</b>	Red Oak 3/4" x 7-1/4" Bending (29 pieces)
<b>RO-12</b>	Red Oak 3/4" x 11-1/4" S4S Lumber
<b>MDF-06</b>	MDF 11/16" x 5-1/4"
<b>MDF-08</b>	MDF 11/16" x 7-1/4"
<b>MDF-12</b>	MDF 11/16" x 11-1/4"

# WOOD MOULDING & FLEXIBLE TRIM



<b>RO-C8</b>	Red Oak 2-1/2" x 11/16" Colonial Casing
<b>PG-C8</b>	Paint Grade 2-1/2" x 11/16" Colonial Casing
<b>FLEX-C8</b>	Paint Grade 2-1/2" x 11/16" Colonial Casing



<b>PG-CAP MOULD</b>	Paint Grade 1-1/8" x 3/8" Cap Mould
---------------------	-------------------------------------



<b>RO-6007</b>	Red Oak 1-3/4" Filet
<b>PG-6007</b>	Paint Grade 1-3/4" Filet



<b>RO-6050</b>	Red Oak 1-1/4" Filet
<b>PG-6050</b>	Paint Grade 1-1/4" Filet



<b>RO-PM-1</b>	Red Oak 11/16" x 1/-1/4" RAB, Panel Mould
<b>PG-PM-1</b>	Paint Grade 11/16" x 1/-1/4" RAB, Panel Mould
<b>Flex-PM-1</b>	Flexible Smooth 11/16" x 1/-1/4" RAB, Panel Mould
<b>Flex-PM-1-WG</b>	Flexible Wood Grain 11/16" x 1/-1/4" RAB, Panel Mould (1/4" Offset)



<b>RO-PM-2</b>	Red Oak 11/16" x 1/-1/4" RAB, Panel Mould
<b>PG-PM-2</b>	Paint Grade 11/16" x 1/-1/4" RAB, Panel Mould
<b>Flex-PM-2</b>	Flexible Smooth 11/16" x 1/-1/4" RAB, Panel Mould
<b>Flex-PM-2-WG</b>	Flexible Wood Grain 11/16" x 1/-1/4" RAB, Panel Mould (3/4" Offset)



<b>RO-PM-5</b>	Red Oak 11/16" x 1-1/8" Flat Panel Mould
<b>PG-PM-5</b>	Paint Grade 11/16" x 1-1/8" Flat Panel Mould
<b>Flex-PM-5</b>	Flexible Smooth 11/16" x 1-1/8" Flat Panel Mould
<b>Flex-PM-5-WG</b>	Flexible Wood Grain 11/16" x 1-1/8" Flat Panel Mould



<b>RO-8050</b>	Red Oak 7/16" x 3/4" Base Shoe Mould
<b>Flex-MS-127</b>	Flexible Smooth 7/16" x 3/4" Base Shoe Mould
<b>Flex-MS-127-WG</b>	Flexible Wood Grain 7/16" x 3/4" Base Shoe Mould



<b>RO-8060</b>	Red Oak 3/4" x 3/4" Cove Mould
<b>PG-8060</b>	Paint Grade 3/4" x 3/4" Cove Mould



<b>RO-8065</b>	Red Oak 1/2" x 1/2" Cove Mould
<b>PG-8065</b>	Paint Grade 1/2" x 1/2" Cove Mould
<b>Flex-MS-101</b>	Flexible Smooth 1/2" x 1/2" Cove Mould
<b>Flex-MS-101-WG</b>	Flexible Wood Grain 1/2" x 1/2" Cove Mould

# ACCESSORIES

## WALL RAIL BRACKET

1-1/4" x 2-3/8" Mounting Plate  
3" Extension From Wall



- HFBC.3002 (BRUSHED CHROME)
- HFCV.3002 (COPPER VEIN)
- HFORB.3002 (OIL RUBBED BRONZE)
- HFORC.3002 (OIL RUBBED COPPER)
- HFPB.3002 (POLISHED BRASS)
- HFSC.3002 (SATIN CLEAR)
- HFAG.3002 (ASH GREY)
- HFSTB.3002 (SATIN BLACK)

## HANDRAIL BRACKET

2-1/16" Rd. Mounting Plate  
3" Extension From Wall



- HFBC.3003 (BRUSHED CHROME)
- HFGB.3003 (DORADO GOLD)
- HFNL.3003 (NICKEL)
- HFCV.3003 (COPPER VEIN)
- HFORB.3003 (OIL RUBBED BRONZE)
- HFORC.3003 (OIL RUBBED COPPER)
- HFPB.3003 (POLISHED BRASS)
- HFSC.3003 (SATIN CLEAR)
- HFAG.3003 (ASH GREY)
- HFSTB.3003 (SATIN BLACK)

## NEWEL MOUNT HANDRAIL BRACKET



HT. 1-3/4"  
Base = 1-1/2" sq.  
ADJUSTABLE



- HF17.4001  
Stainless Steel(304)
- HFSTB17.4001  
Satin Black

## HANDRAIL BRACKET



HT. 2-1/2"  
Base = 1-1/2" x 2"  
Extends 3-1/4" off wall  
ADJUSTABLE



- HF17.4002  
Stainless Steel(304)
- HFSTB17.4002  
Satin Black

mounting hardware included

## WOOD GLUE & FILLER



- S-9202 (1 Gal.)  
aware include
- S-9203 (32 oz.)
- S-9204 (16 oz.)
- S-9205 (8 oz.)

- FAM-O-WOOD  
RO-9208 (Red Oak)

## EPOXY GUN-EPC-101



## EPOXY-EPC-410 EPC-410-BLACK



## EPOXY PASTE EPC-7



## OAK ROSETTES



- RO-7033  
4" x 5-1/2"  
(Red Oak)
- RO-7037  
4" x 5-1/2"  
(Red Oak)
- RO-7039  
4" x 4"  
(Red Oak)

## OAK PLUGS

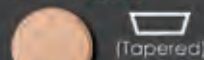

- RO-9001 (3/8")
- RO-9002 (1/2")
- RO-9003 (5/8")
- RO-9004 (3/4")
- RO-9005 (1")
- RO-9006 (1-1/4")
- RO-9007 (1-1/2")

## NEWEL FASTENER S-9403



Sure Tite

## NEWEL FASTENER S-9401



Key Lock

## RAIL BOLT KIT S-9600

(Includes hex nut, spacer  
and 1" Red Oak plug)



## RAIL BOLT DRIVER S-9600-D

(fits machine thread)



sold individually

## DOWEL SCREW C-905-2

(25 per bag)

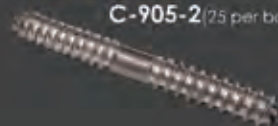

## DRIVER C-905-2D

(fits wood screw thread)



sold individually

# AXIA<sup>®</sup>

## STAIR & RAILING SYSTEMS



STYLE



QUALITY



VALUE

We offer the most in-demand, high quality stainless steel stair & railing systems at the lowest price possible. From day one, we set out to do things a little bit different. Our goal has always been to provide stainless systems that are ideal for the residential stair installer/builder while also surpassing the expectations of the most discerning homeowners.

### Sales Displays & Product Samples

Our wide variety of sales displays will provide you with the tools to sell products. We have sizes to fit your floor space. Custom displays are also available.



Axia Post Systems - Floor Display  
Dimensions: 56" W x 8" D x 44" H



Axia Post Systems - Table Top Display  
Dimensions: 30" W x 8" D x 24" H

### Estimation Services

We offer full estimation services based on your plans. We can also offer quick-quoting based on the designs featured in our design guide.



### Product Catalog

Full line product catalog featuring:  
Post Railing Systems  
Round Series  
Square Series  
Glass Railing Systems  
Standoff Series  
U-Channel Series  
Installation Accessories

### Design Guide

Features over thirty pre-configured stair and balcony designs for inspiration and quick quoting. This guide is a valuable sales tool and visual guide to navigate our systems.

### Installation Guides

Get pro level instruction on the best way to install our systems. Loaded with tips and tricks for best results these guides cover all the basics of installation and tools/accessories.



# MARKETING TOOLS

## House of Forgings Modular Floor Display

**Quick Installation:**  
Fully assembled in under 15 minutes!  
Tools required: Phillips screwdriver



Display Dimensions:  
30" W x 30" D x 72" H

## Retail Displays Increase Sales

**MODULAR DISPLAY:** Our Modular Display is available as a free standing unit containing six removable panels.

**DISPLAY PANELS:** If floor space is an issue, we have you covered. All of our Display Panels can be ordered individually and come with wall hangers and product brochure holders pre installed.

**ORDERING:** To order a Modular Display or specific Display Panels, please contact your sales representative at (866) 443-4848

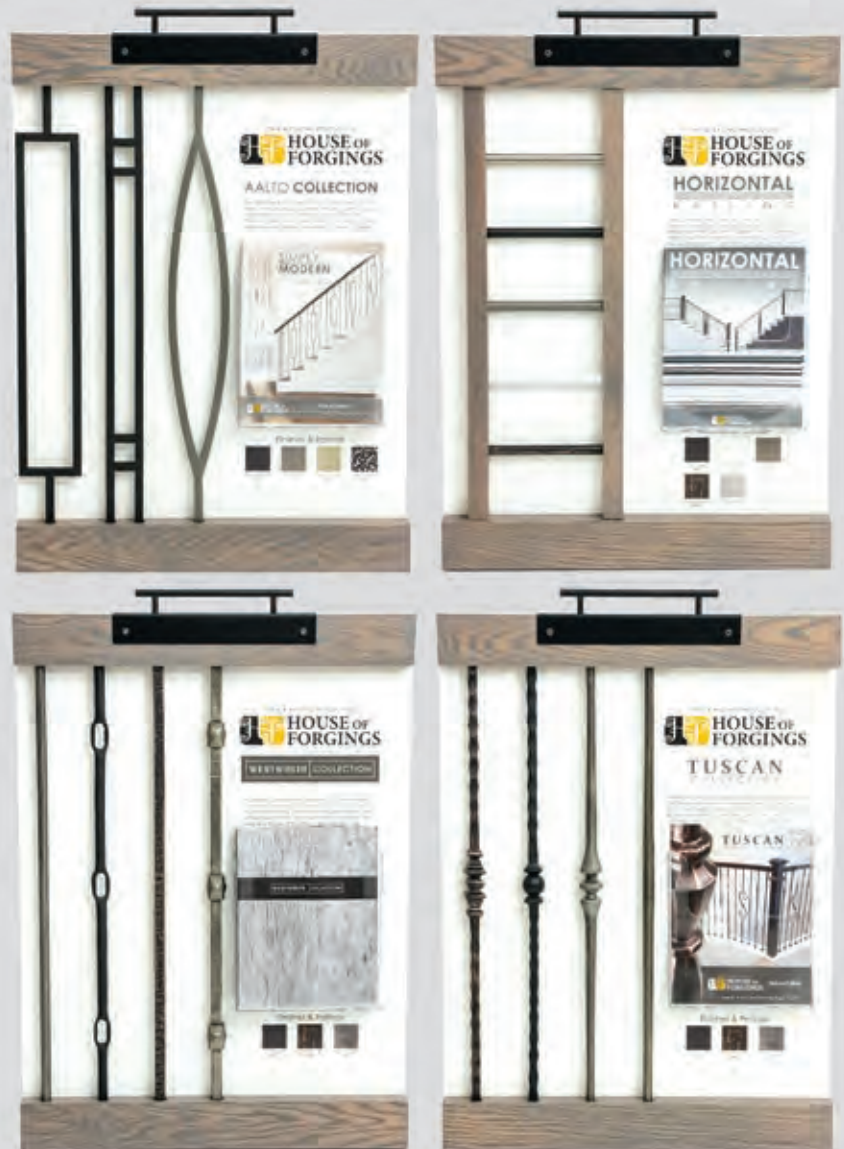

Panel Dimensions: 24" W x 2" D x 30" H

### Panels available for:

Soho Balustrade - Foundation Balusters - Horizontal Bar Railing  
Wentworth Collection - Aalto Collection - Tuscan Collection



# MARKETING TOOLS

House of Forgings Sales & Marketing Support

## Sales Displays & Product Samples

Our wide variety of sales displays will provide you with the tools to sell products. We have sizes to fit your floor space. Custom displays are also available.



Powder Coated Finishes  
Sample Chips



Powder Coated Finishes  
Sample Balusters - 12" Length  
Handrail Profile Samples  
Carrying Case (4" x 14" x 25")



Carousel Floor Display  
Dimensions:  
18" W x 18" D x 48" H



Horizontal Bar Railing  
Table Top Display  
Dimensions: 24" W x 8" D x 18" H



Axia Post Systems  
Table Top Display  
Dimensions: 30" W x 8" D x 24" H

## Software & Design

Web based Stair Artist stair design tool makes it easy to plan your staircase project. Our extensive library of CAD images and product photos will aid and inspire you in designing your staircase.



## Marketing Literature

We offer a wide array of marketing literature designed to support product sales: product catalogs, brochures, flyers, postcards and customized literature are available through our authorized dealer program.

Inquire with your sales representative about product catalogs and additional product support.

# CUSTOMIZATION OPTIONS

Iron Fabrication, Finishing and More

## Transform Existing Products Into New Creations

We manage your fabrication project from start to finish, offering design services, estimation, project management and quality assurance. We take the hassle out of your project, leaving you more time and resources to focus on satisfying your customers with impeccable end results.



### Step 1 - EXPLORE

Find existing House of Forgings parts that inspire your vision.

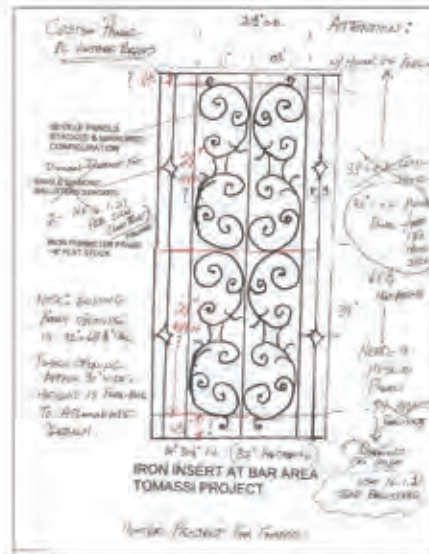

### Step 2 - CONCEPT

Share your ideas and specifications for modifying an existing part.

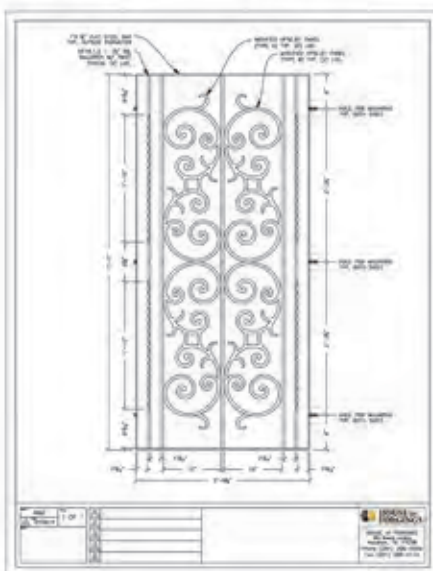

### Step 3 - DESIGN

We help take your rough concepts and turn them into professional designs for your final approval.



Oil Rubbed Bronze Finish  
hand applied over  
Satin Black powdercoat

### Step 4 - FINISHED PRODUCT

Once approved, your custom product is produced (raw or powder coated) and shipped within 2-6 weeks.

# EURO FORGE

Access to Our World Class Manufacturing

ITALY · USA

DESIGN COLLABORATIVE

## You Design It. We Bring It to Life!

Together with our Italian factory we bring your vision to reality. Whether you have a simple inspiration photo or detailed drawings of a single element or entire staircase we specialize in a full range of manufacturing options ideally suited to exceed your expectations.

Forging - Casting - Stamping - Bending - Rolling - Laser Cutting

Stair Parts - Decorative Panels - Window Coverings - Furniture Components - & More

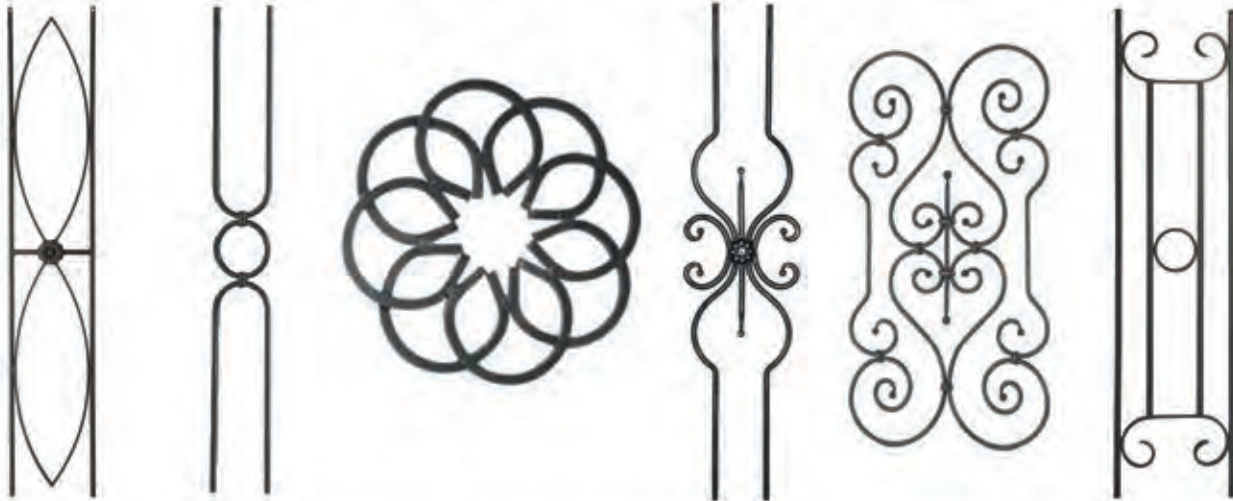

## THERMA-CUT LASER CUTTING

Your drawings take shape with fully custom laser cutting for interior or exterior applications.

Sheet metal is thermally cut with high accuracy to create and transform ordinary sheet metal into decorative outdoor fencing, gates, interior panels, shelves, partitions, iron tapestries, and more.

TYPE OF MATERIAL	THICKNESS	MAXIMUM SIZE
Raw Metal (black or pickled)	20ga to 3/4"	6'6" x 13'
Pre-Galvanized	20ga to 6ga	4'11" x 13'
Corten	16ga to 3/8"	4'11" x 9'10"
Stainless 304/316	20ga to 9/16"	6'6" x 13'

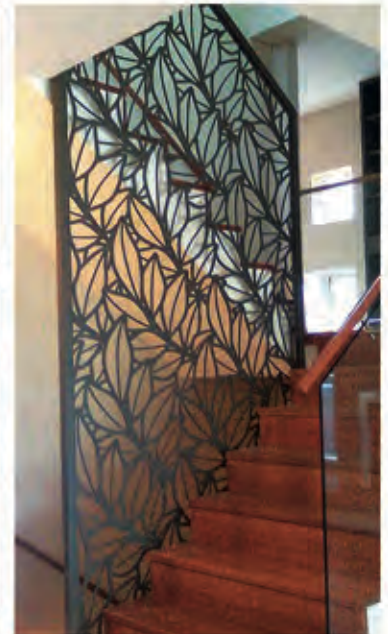

Inquire for more information

